

Nidec

All for dreams



User Guide

SI-PROFIBUS

Part Number: 0478-0011-04

Issue Number: 4

Original Instructions

For the purposes of compliance with the EU Machinery Directive 2006/42/EC, the English version of this manual is the Original Instructions. Manuals in other languages are Translations of the Original Instructions.

Documentation

Manuals are available to download from the following locations: <http://www.drive-setup.com/ctdownloads>

The information contained in this manual is believed to be correct at the time of printing and does not form part of any contract. The manufacturer reserves the right to change the specification of the product and its performance, and the contents of the manual, without notice.

Warranty and Liability

In no event and under no circumstances shall the manufacturer be liable for damages and failures due to misuse, abuse, improper installation, or abnormal conditions of temperature, dust, or corrosion, or failures due to operation outside the published ratings. The manufacturer is not liable for consequential and incidental damages. Contact the supplier of the drive for full details of the warranty terms.

Environmental policy

Control Techniques Ltd operates an Environmental Management System (EMS) that conforms to the International Standard ISO 14001.

Further information on our Environmental Policy can be found at: <http://www.drive-setup.com/environment>

Restriction of Hazardous Substances (RoHS)

The products covered by this manual comply with European and International regulations on the Restriction of Hazardous Substances including EU directive 2011/65/EU and the Chinese Administrative Measures for Restriction of Hazardous Substances in Electrical and Electronic Products.

Disposal and Recycling (WEEE)



When electronic products reach the end of their useful life, they must not be disposed of along with domestic waste but should be recycled by a specialist recycler of electronic equipment. Control Techniques products are designed to be easily dismantled into their major component parts for efficient recycling. The majority of materials used in the product are suitable for recycling.

Product packaging is of good quality and can be re-used. Large products are packed in wooden crates. Smaller products are packaged in strong cardboard cartons which have a high recycled fibre content. Cartons can be re-used and recycled. Polythene, used in protective film and bags for wrapping the product, can be recycled. When preparing to recycle or dispose of any product or packaging, please observe local legislation and best practice.

REACH legislation

EC Regulation 1907/2006 on the Registration, Evaluation, Authorisation and restriction of Chemicals (REACH) requires the supplier of an article to inform the recipient if it contains more than a specified proportion of any substance which is considered by the European Chemicals Agency (ECHA) to be a Substance of Very High Concern (SVHC) and is therefore listed by them as a candidate for compulsory authorisation.

Further information on our compliance with REACH can be found at: <http://www.drive-setup.com/reach>

Registered Office

Nidec Control Techniques Ltd
The Gro
Newtown
Powys
SY16 3BE
UK

Registered in England and Wales. Company Reg. No. 01236886.

Copyright

The contents of this publication are believed to be correct at the time of printing. In the interests of a commitment to a policy of continuous development and improvement, the manufacturer reserves the right to change the specification of the product or its performance, or the contents of the guide, without notice.

All rights reserved. No parts of this guide may be reproduced or transmitted in any form or by any means, electrical or mechanical including photocopying, recording or by an information storage or retrieval system, without permission in writing from the publisher.

Copyright © January 2018 Nidec Control Techniques Ltd

Contents

1	Safety information	6
1.1	Warnings, Cautions and Notes	6
1.2	Important safety information. Hazards. Competence of designers and installers	6
1.3	Responsibility	6
1.4	Compliance with regulations	6
1.5	Electrical hazards	7
1.6	Stored electrical charge	7
1.7	Mechanical hazards	7
1.8	Access to equipment	7
1.9	Environmental limits	8
1.10	Hazardous environments	8
1.11	Motor	8
1.12	Mechanical brake control	8
1.13	Adjusting parameters	8
1.14	Electromagnetic compatibility (EMC)	8
2	Introduction	9
2.1	What is PROFIBUS-DP?	9
2.2	Firmware Statement	11
2.3	About SI-PROFIBUS	11
2.4	General specification	12
2.5	Option module identification	12
2.6	Conventions used in this guide	13
3	Mechanical installation	14
3.1	General Installation	14
4	Electrical installation	17
4.1	Terminal descriptions	17
4.2	PROFIBUS-DP connectors	18
4.3	PROFIBUS-DP cable	18
4.4	Cable shielding	18
4.5	General grounding considerations	18
4.6	Network termination	18
4.7	Maximum network length / device loading	19
4.8	Node addressing	19
4.9	Spurs	19
4.10	Minimum node to node cable length	19
4.11	Grounding	19
5	Getting started	20
5.1	Set-up flow chart	21
5.2	Single line descriptions	22
6	Parameters	28
6.1	Menus	28
6.2	Module menu 0 - module information	28
6.3	Module menu 1 - PROFIBUS Set-up	31
6.4	Module menu 2 - Input mapping	43
6.5	Module menu 3 - Output mapping	44
6.6	Module menu 4 - Fault values	45
6.7	Module menu 9 - Resources	46
7	GSD Files	47
7.1	What are GSD Files?	47
7.2	Data consistency	47
7.3	Data configuration	47
7.4	PROFIBUS DP-V1	48
7.5	GSD compatibility table	48

8	Cyclic data	49
8.1	What is cyclic data?	49
8.2	Data formats	49
8.3	Mapping conflicts	51
8.4	Cyclic data mapping errors	51
8.5	Mapping limitations	51
8.6	Disabling mappings	52
8.7	Master configuration	52
9	Non-cyclic data	53
9.1	What is non-cyclic data?	53
9.2	Configuration using non-cyclic data	53
9.3	SI-PROFIBUS non-cyclic overview	53
10	Control and status words	56
10.1	What are control and status words?	56
10.2	Control word	56
10.3	Status word	58
11	Diagnostics	61
11.1	Overview	61
11.2	Drive trip display codes	61
12	PROFIdrive profile (V4)	66
12.1	What is PROFIdrive profile?	66
12.2	Standard Telegram 1	66
12.3	Main Setpoint	67
12.4	Main Actual Value	67
12.5	PROFIdrive (V4) State Machine	68
12.6	Normal Run Sequence	68
12.7	Stopping the motor using PROFIdrive	71
12.8	Jogging	71
12.9	PROFIdrive control word	72
12.10	PROFIdrive status word	73
12.11	PROFIdrive PNU access	74
12.12	Fault Buffer	75
12.13	Drive Identification	77
12.14	Identification and Maintenance Functions	77
13	Advanced features	78
13.1	SYNC and FREEZE Mode	78
13.2	Inter-option communication timing	78
13.3	Multi-master operation	78
14	Legacy features	79
14.1	Network compatibility mode	79
14.2	PPO Types	80
14.3	Configuring the Profile	82
14.4	Setting the non-cyclic mode (non-cyclic over cyclic)	82
14.5	Mode 1 - CT Single Word mode	82
14.6	Reading parameters using CT Single Word	84
14.7	Mode 2 - PPO 4 Word mode	92
15	Glossary of terms	100

1 Safety information

1.1 Warnings, Cautions and Notes



A **Warning** contains information, which is essential for avoiding a safety hazard.



A **Caution** contains information, which is necessary for avoiding a risk of damage to the product or other equipment.

NOTE

A **Note** contains information, which helps to ensure correct operation of the product.

1.2 Important safety information. Hazards. Competence of designers and installers

This guide applies to products which control electric motors either directly (drives) or indirectly (controllers, option modules and other auxiliary equipment and accessories). In all cases the hazards associated with powerful electrical drives are present, and all safety information relating to drives and associated equipment must be observed.

Specific warnings are given at the relevant places in this guide.

Drives and controllers are intended as components for professional incorporation into complete systems. If installed incorrectly they may present a safety hazard. The drive uses high voltages and currents, carries a high level of stored electrical energy, and is used to control equipment which can cause injury. Close attention is required to the electrical installation and the system design to avoid hazards either in normal operation or in the event of equipment malfunction. System design, installation, commissioning/ start-up and maintenance must be carried out by personnel who have the necessary training and competence. They must read this safety information and this guide carefully.

1.3 Responsibility

It is the responsibility of the installer to ensure that the equipment is installed correctly with regard to all instructions given in this guide. They must give due consideration to the safety of the complete system, so as to avoid the risk of injury both in normal operation and in the event of a fault or of reasonably foreseeable misuse.

The manufacturer accepts no liability for any consequences resulting from inappropriate, negligent or incorrect installation of the equipment.

1.4 Compliance with regulations

The installer is responsible for complying with all relevant regulations, such as national wiring regulations, accident prevention regulations and electromagnetic compatibility (EMC) regulations. Particular attention must be given to the cross-sectional areas of conductors, the selection of fuses or other protection, and protective ground (earth) connections.

This guide contains instructions for achieving compliance with specific EMC standards.

All machinery to be supplied within the European Union in which this product is used must comply with the following directives:

2006/42/EC Safety of machinery.

2014/30/EU: Electromagnetic Compatibility.

1.5 Electrical hazards

The voltages used in the drive can cause severe electrical shock and/or burns, and could be lethal. Extreme care is necessary at all times when working with or adjacent to the drive. Hazardous voltage may be present in any of the following locations:

- AC and DC supply cables and connections
- Output cables and connections
- Many internal parts of the drive, and external option units

Unless otherwise indicated, control terminals are single insulated and must not be touched.

The supply must be disconnected by an approved electrical isolation device before gaining access to the electrical connections.

The STOP and Safe Torque Off functions of the drive do not isolate dangerous voltages from the output of the drive or from any external option unit.

The drive must be installed in accordance with the instructions given in this guide. Failure to observe the instructions could result in a fire hazard.

1.6 Stored electrical charge

The drive contains capacitors that remain charged to a potentially lethal voltage after the AC supply has been disconnected. If the drive has been energized, the AC supply must be isolated at least ten minutes before work may continue.

1.7 Mechanical hazards

Careful consideration must be given to the functions of the drive or controller which might result in a hazard, either through their intended behaviour or through incorrect operation due to a fault. In any application where a malfunction of the drive or its control system could lead to or allow damage, loss or injury, a risk analysis must be carried out, and where necessary, further measures taken to reduce the risk - for example, an over-speed protection device in case of failure of the speed control, or a fail-safe mechanical brake in case of loss of motor braking.

With the sole exception of the Safe Torque Off function, none of the drive functions must be used to ensure safety of personnel, i.e. they must not be used for safety-related functions.

The Safe Torque Off function may be used in a safety-related application. The system designer is responsible for ensuring that the complete system is safe and designed correctly according to the relevant safety standards.

The design of safety-related control systems must only be done by personnel with the required training and experience. The Safe Torque Off function will only ensure the safety of a machine if it is correctly incorporated into a complete safety system. The system must be subject to a risk assessment to confirm that the residual risk of an unsafe event is at an acceptable level for the application.

1.8 Access to equipment

Access must be restricted to authorized personnel only. Safety regulations which apply at the place of use must be complied with.

1.9 Environmental limits

Instructions in this guide regarding transport, storage, installation and use of the equipment must be complied with, including the specified environmental limits. This includes temperature, humidity, contamination, shock and vibration. Drives must not be subjected to excessive physical force.

1.10 Hazardous environments

The equipment must not be installed in a hazardous environment (i.e. a potentially explosive environment).

1.11 Motor

The safety of the motor under variable speed conditions must be ensured.

To avoid the risk of physical injury, do not exceed the maximum specified speed of the motor.

Low speeds may cause the motor to overheat because the cooling fan becomes less effective, causing a fire hazard. The motor should be installed with a protection thermistor. If necessary, an electric forced vent fan should be used.

The values of the motor parameters set in the drive affect the protection of the motor. The default values in the drive must not be relied upon. It is essential that the correct value is entered in the Motor Rated Current parameter.

1.12 Mechanical brake control

Any brake control functions are provided to allow well co-ordinated operation of an external brake with the drive. While both hardware and software are designed to high standards of quality and robustness, they are not intended for use as safety functions, i.e. where a fault or failure would result in a risk of injury. In any application where the incorrect operation of the brake release mechanism could result in injury, independent protection devices of proven integrity must also be incorporated.

1.13 Adjusting parameters

Some parameters have a profound effect on the operation of the drive. They must not be altered without careful consideration of the impact on the controlled system. Measures must be taken to prevent unwanted changes due to error or tampering.

1.14 Electromagnetic compatibility (EMC)

Installation instructions for a range of EMC environments are provided in the relevant Power Installation Guide. If the installation is poorly designed or other equipment does not comply with suitable standards for EMC, the product might cause or suffer from disturbance due to electromagnetic interaction with other equipment. It is the responsibility of the installer to ensure that the equipment or system into which the product is incorporated complies with the relevant EMC legislation in the place of use.

2 Introduction

2.1 What is PROFIBUS-DP?

PROFIBUS-DP (Decentralized Peripheral) is a networking system which falls into the generic category of fieldbus. Fieldbuses are generally defined as industrial networking systems that are intended to replace traditional wiring systems. Figure 2-1 shows the traditional cabling requirements to transfer signals between 2 slaves and a master.

Figure 2-1 Traditional cable layout

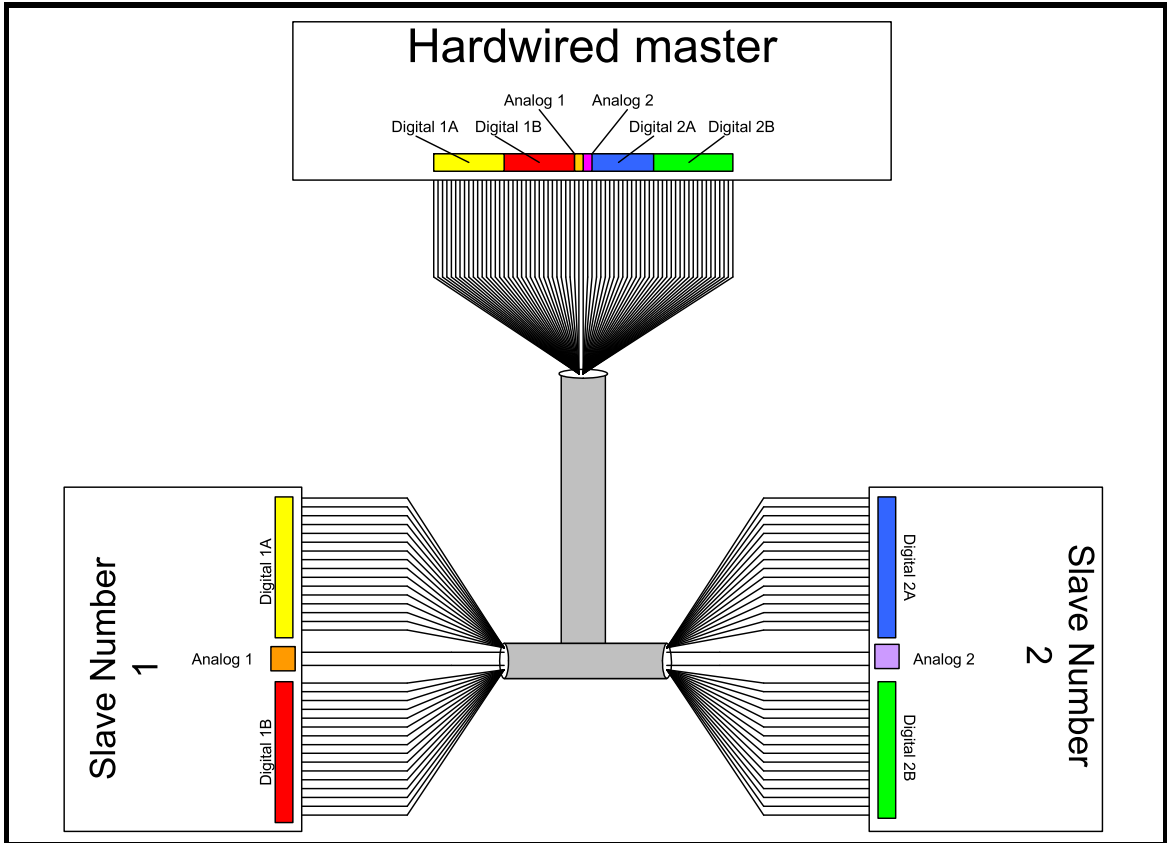

Table 2-1 details how the wiring is used to communicate data between the master and the slaves. Each signal that is communicated requires one signal wire giving a total of 66 signal wires plus a 0V return.

Table 2-1 Traditional wiring details

Number of signals	Type	Source / Destination	Description
16	digital Inputs	slave 1 to master	status signals
	digital outputs	master to slave 1	control signals
1	analog output	master to slave 1	control signal
16	digital inputs	slave 2 to master	status signals
	digital outputs	master to slave 2	control signals
1	analog output	master to slave 2	control signal

A fieldbus topology such as PROFIBUS-DP allows the same configuration to be realized using only two signal wires plus a shield. This method of communication saves significantly on the amount of cabling required and can improve overall system reliability as the number of interconnections is greatly reduced.

Figure 2-2 shows a typical PROFIBUS-DP network system transferring the same signals as given in the traditionally wired example. The signals are now transmitted by converting them into a serial data stream which is received by the master as if they were connected using traditional wiring. The data stream on PROFIBUS-DP allows up to 64 (32 input and 32 output) independent values to be sent or received by the master, in addition to a single channel allowing for random access to drive parameters.

Figure 2-2 PROFIBUS-DP cable layout

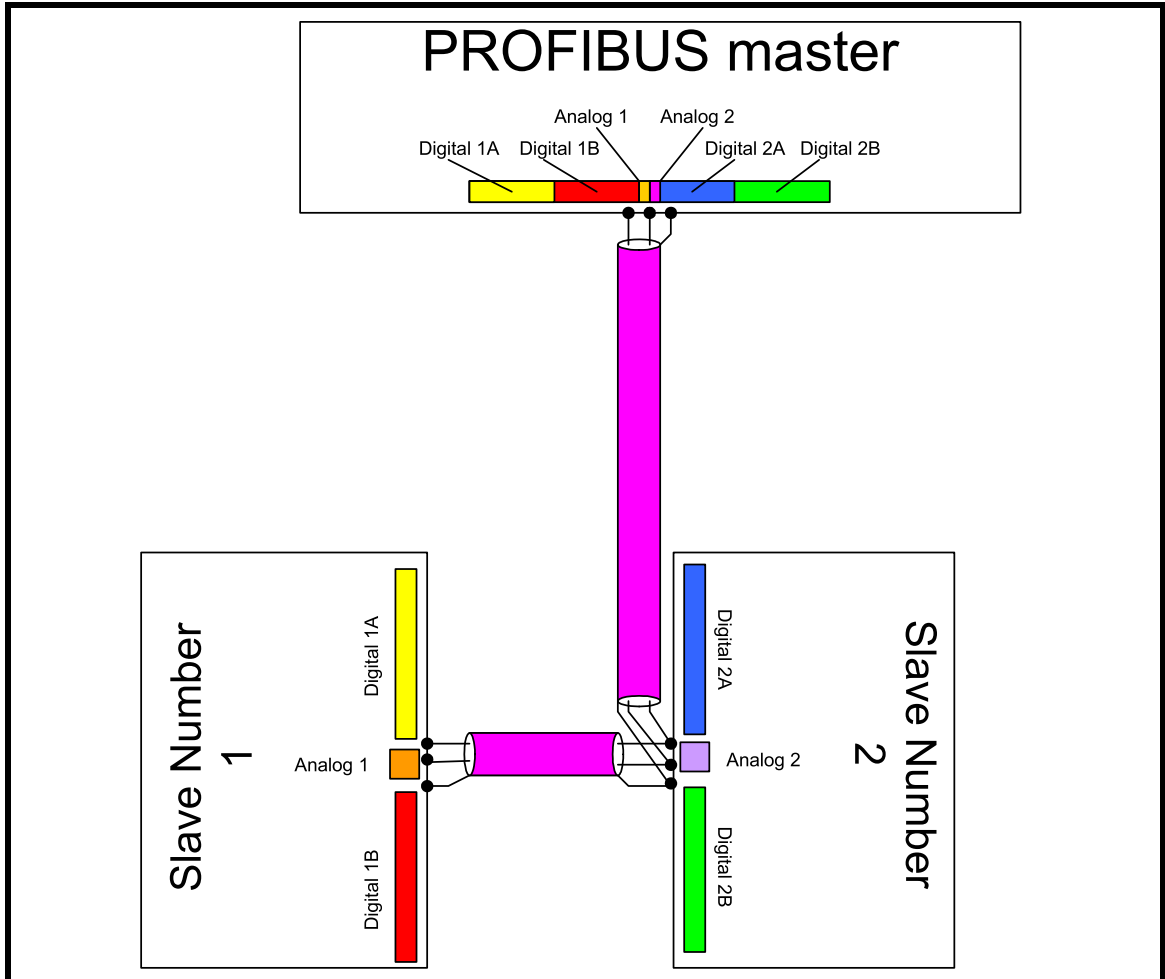

Table 2-2 Data mappings for SI-PROFIBUS

Number of network words	Type	Source / Destination	Description
1	digital Inputs	slave 1 to master	status signals
	digital outputs	master to slave 1	control signals
	analog output		control signal
	digital inputs	slave 2 to master	status signals
	digital outputs	master to slave 2	control signals
	analog output		control signal

Table 2-2 details the number of data words used to communicate the signals using the PROFIBUS-DP network. It can be seen that the resulting reduction in cabling is significant.

PROFIBUS-DP can transfer data using two distinct modes. The first of these modes is cyclic, where signals are sent in predefined blocks at regular intervals. This is the equivalent of the hard-wired example in Figure 2-1.

The second method of transfer is called non-cyclic data, and is used for sending values that only need to be changed occasionally or where the source or destination of the signal changes. This is the equivalent of a temporary patch lead that is removed after use.

2.2 Firmware Statement

This option module is supplied with the latest firmware version. When retro-fitting to an existing system, all firmware versions should be verified to confirm the same functionality as option modules of the same type already present. This also applies to products returned from a Control Techniques Service Centre or Repair Centre. If there is any doubt please contact the supplier of the product.

The firmware version of the option module can be identified by looking at Pr **MM.002** where **MM** is the relevant menu number for the option module slot being used. See Pr **MM.002** description later in this manual for more information. The firmware version takes the form of **ww.xx.yy.zz** seen in **MM.002**.

2.3 About SI-PROFIBUS

SI-PROFIBUS is a fieldbus option module that can be installed to the option module slot(s) in any of the following drives to provide PROFIBUS-DP slave connectivity:

- Unidrive M700
- Unidrive M200/M300/M400 (firmware V01.03.00 or later)

It is possible to use more than one SI-PROFIBUS or a combination of SI-PROFIBUS and other option modules to add additional functionality such as extended I/O, gateway functionality, or additional PLC features.

Figure 2-3 SI-PROFIBUS module



2.4 General specification

2.4.1 Features

The following section gives a brief overview of the functionality available within SI-PROFIBUS.

- Supported data rates (bits/s): 12M, 6.0M, 3.0M, 1.5M, 500k, 187.5k, 93.75k, 45.45k, 19.2k, 9.6k.
- Maximum of 32 input and 32 output cyclic data words supported
- PROFIdrive profile (V4) supported
- DP-V1 Non-cyclic data channel supported
- Parallel acyclic/cyclic data communication

The SI-PROFIBUS is powered from the host drive's internal power supply.

2.5 Option module identification

The SI-PROFIBUS can be identified by:

1. The label located on the topside of the option module.
2. The color coding across the front of the SI-PROFIBUS (purple).

Figure 2-4 SI-PROFIBUS labels

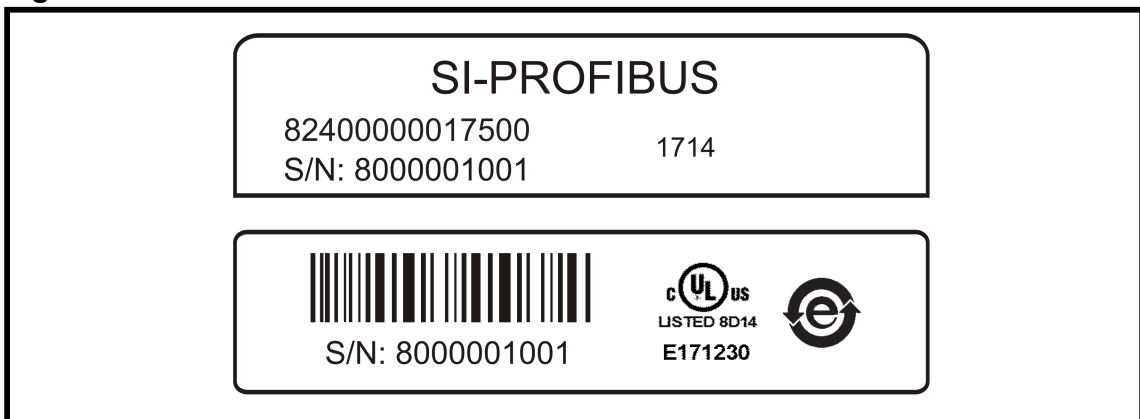

2.5.1 Date code format

The date code is four numbers. The first two numbers indicate the year and the remaining numbers indicate the week of the year in which the drive was built.

Example:

A date code of 1710 would correspond to week 10 of year 2017.

2.5.2 Back-up power supply

The required drive can be connected to a 24 Vdc back-up power supply (refer to the relevant drive documentation for connection details). This keeps the control electronics and option module powered up, allowing the SI-PROFIBUS to continue communicating with the PROFIBUS-DP master controller when the main supply to the drive is switched off. For every SI-PROFIBUS installed allow for an extra 70 mA of supply current to be drawn from the back-up supply.

2.6 Conventions used in this guide

The configuration of the host drive and option module is done using menus and parameters. A menu is a logical collection of parameters that have similar functionality. In the case of an option module, the parameters relating to the set-up of the option module will appear in menu 15, 16 or 17 depending on which slot the module is installed in and the set-up of the option slot identifiers (Pr **11.056**); the internal menus of the option module will appear before menu 0 and after menu 41.

NOTE

For M200, M300 and M400 drives, the module set-up parameters will appear in menu 15.

The method used to determine the menu or parameter is as follows:

- Pr **S.mm.ppp** - Where S signifies the option module slot number and **mm.ppp** signifies the menu and parameter number of the option module's internal menus and parameters. If the option module slot number is not specified then the parameter reference is for a drive parameter.
- Pr **mm.ppp** - Where **mm** signifies the menu allocated to the option module set-up menu and ppp signifies the parameter number.

Pr **mm.000** - Signifies parameter number 000 in any drive menu.

3 Mechanical installation



Before installation or removal of an option module from any drive, ensure the AC supply has been disconnected for at least 10 minutes and refer to section 1 *Safety information* on page 6. If using a DC bus supply ensure this is fully discharged before working on any drive or option module.

3.1 General Installation

Installation of the various option modules is illustrated in the following diagrams.

Figure 3-1 Installation of an SI option module on Unidrive M200 to M400 (sizes 2 to 4)

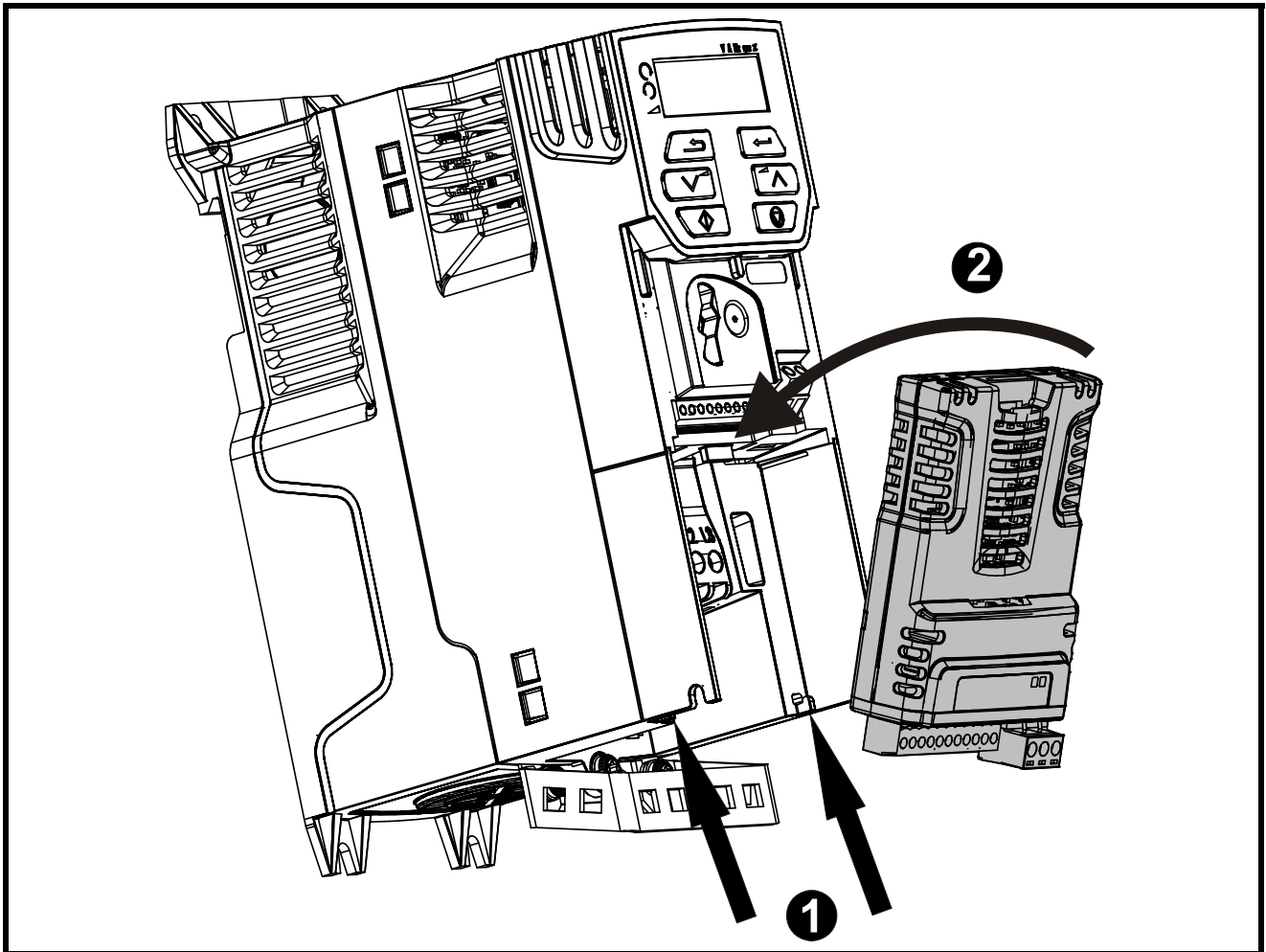

- With the option module tilted slightly backwards, align and locate the two holes in the rear of the option module onto the two tabs (1) on the drive.
- Place the option module onto the drive as shown in (2) until the module clicks into place. The terminal cover on the drive holds the option module in place, so this must now be replaced.

NOTE

The above diagram is for illustration only, the actual option module may be different to the one shown here.

NOTE

Option modules can only be installed on drives that have the option module slot functionality.

Figure 3-2 Installation of an SI option module on Unidrive M200 to M400 (sizes 5 to 9)

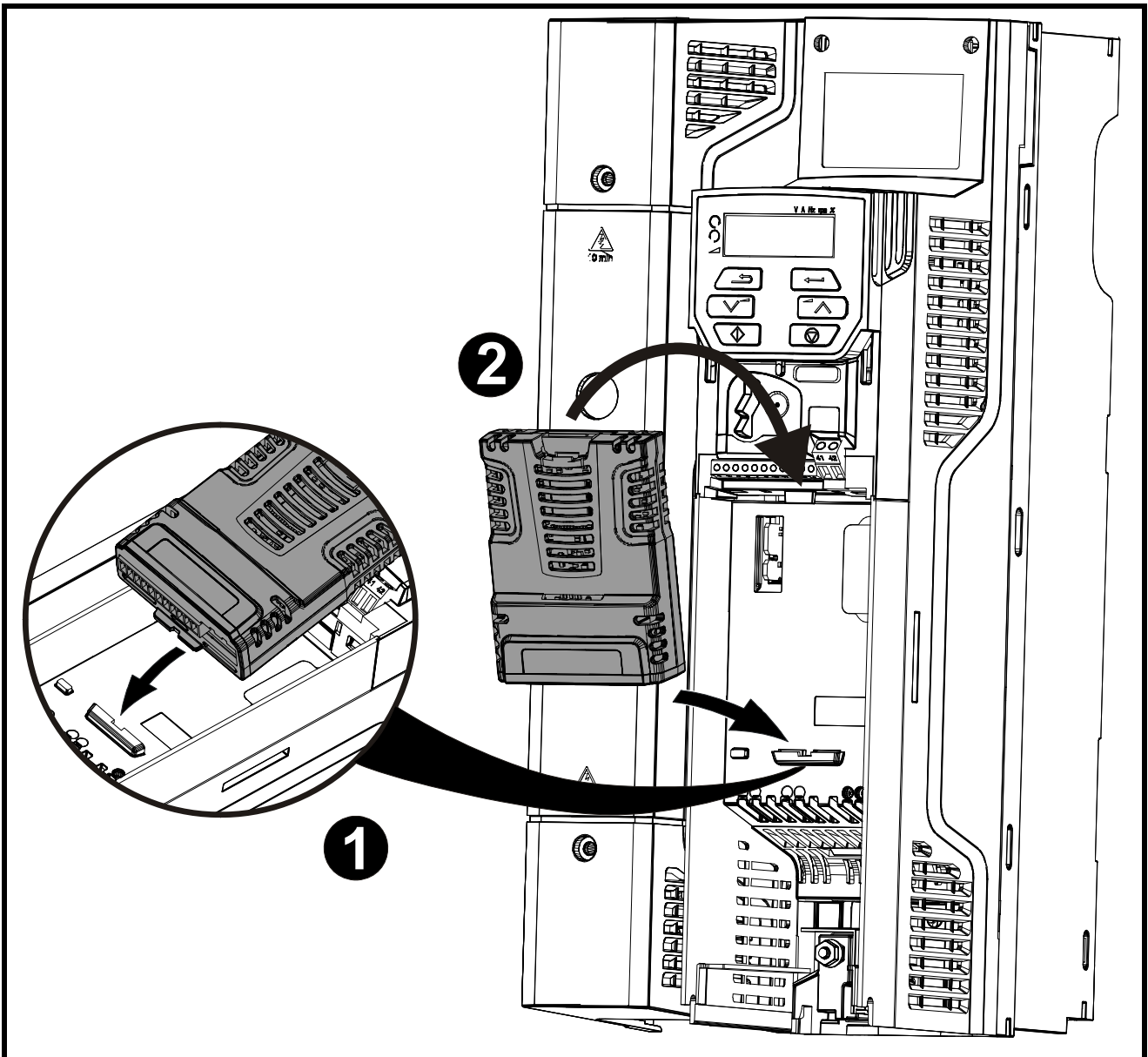

- Place the option module onto the drive as shown in (2) until the module clicks into place. The terminal cover on the drive holds the option module in place, so this must now be replaced.

Safety information	Introduction	Mechanical installation	Electrical installation	Getting started	Parameters	GSD Files	Cyclic data	Non-cyclic data	Control and status words	Diagnostics	PROFIdrive profile (V4)	Advanced features	Legacy features	Glossary of terms
--------------------	--------------	--------------------------------	-------------------------	-----------------	------------	-----------	-------------	-----------------	--------------------------	-------------	-------------------------	-------------------	-----------------	-------------------

Figure 3-3 Installation of an SI option module on Unidrive M600 to M702

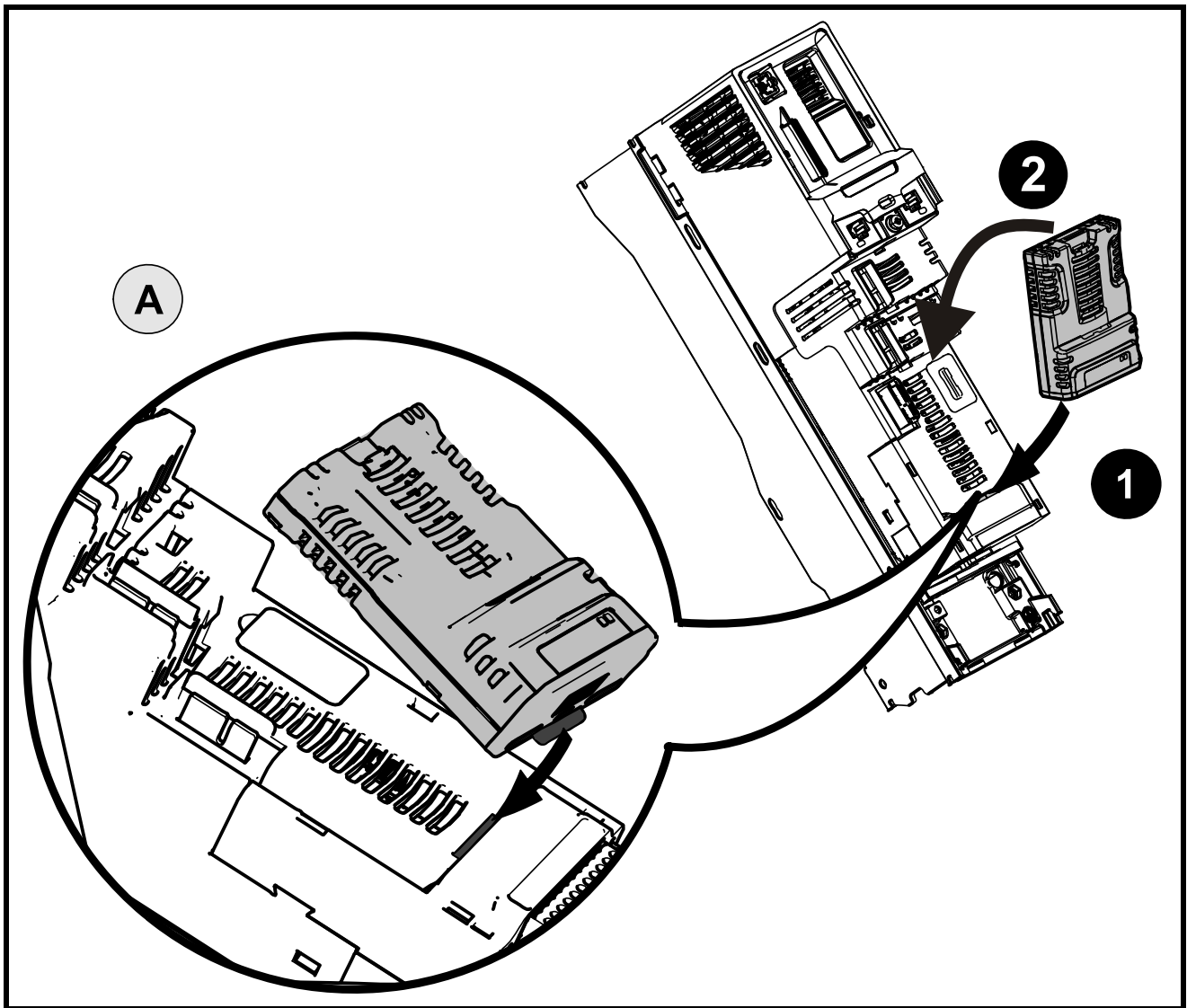

NOTE

Option module slots must be used in the following order: (Slot 3), (Slot 2) then (Slot 1).

- Move the option module in the direction shown (1/2).
- Align and insert the option module tab into the slot provided. This is highlighted in the detailed view (A).
- Press down on the option module until it clicks into place.

4 Electrical installation

4.1 Terminal descriptions

SI-PROFIBUS has a standard 9-way female D-type connector for the PROFIBUS-DP network.

Figure 4-1 SI-PROFIBUS terminals

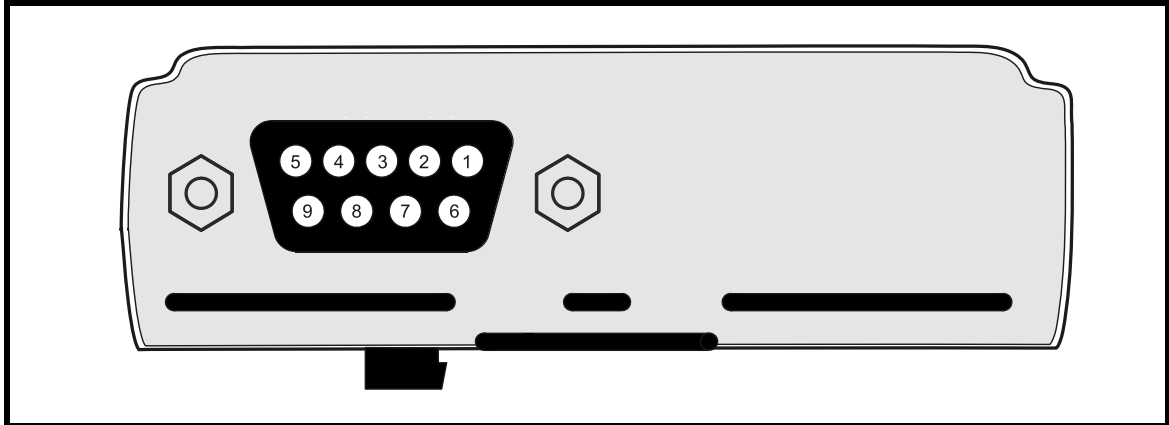
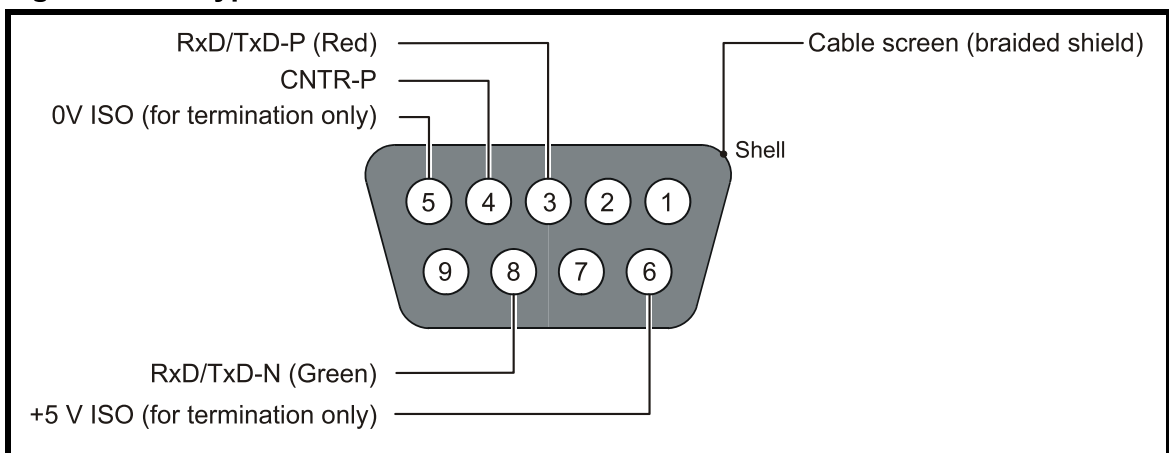

Table 4-1 SI-PROFIBUS D-Type pin out

D-type Terminal	Function	Description
3	RxD/TxD-P	Positive data line (B) - Red
8	RxD/TxD-N	Negative data line (A) - Green
6	+ 5V ISO	+5 V isolated, use only for termination resistors
5	0V ISO	0 V isolated, use only for termination resistors
4	CNTR-P	RTS line
1, Shell	Shield	Cable shield connection

Figure 4-2 D-Type connections



Control Techniques recommend using connectors approved by PROFIBUS International at all times.

4.2 PROFIBUS-DP connectors

There are numerous manufacturers of PROFIBUS-DP connectors. Always ensure that any connectors used on the network are fully approved for use with PROFIBUS-DP networks. Some of the connector types available include built in termination that allows the network to be isolated, this can be very useful when fault finding. For data rates above 1.5 Mbs connectors installed with integrated inductors should be used.

4.3 PROFIBUS-DP cable

PROFIBUS-DP networks can run at high data rates and require cable specifically designed to carry high frequency signals. Low quality cable will attenuate the signals, and may render the signal unreadable for the other nodes on the network. Cable specifications and a list of approved manufacturers of cable for use on PROFIBUS-DP networks are available on the PROFIBUS Nutzerorganization (PNO) website at www.profibus.com.

NOTE Control Techniques can only guarantee correct and reliable operation of the SI-PROFIBUS if all other equipment on the PROFIBUS-DP network (including the network cable) has been approved by the PNO and is correctly installed.

4.4 Cable shielding

Correct shielding of the PROFIBUS-DP cable is required for reliable operation at high data rates, this can be achieved by exposing the cable shield of each PROFIBUS-DP cable and ensuring that they are clamped to the drive grounding metalwork as close as possible to the drive termination, contact your supplier or local Control Techniques Drive Centre for more information.

NOTE Unless there are specific reasons for not grounding the network it is recommended that all drive network connections are correctly grounded. Failure to do so may reduce the noise immunity of the system. If there are specific issues with grounding, alternative methods of connection should be considered such as the use of fibre optic cable.

4.5 General grounding considerations

It is essential that good grounding is provided not only for network stability but more importantly electrical safety. In all instances electrical regulations should be adhered to. As a guide the network cable should be grounded at least once per cabinet, ideally on each drive.

4.6 Network termination

It is very important in high-speed communications networks that the network communications cable is installed with the specified termination resistor network at each end of each segment. This prevents signals from being reflected back down the cable and causing interference.

Most ranges of connectors provide specific parts that incorporate the termination network. Such connectors derive the power from the host device and if the host device is switched off the termination will be lost. To avoid this situation a separate termination device is available that is powered independently of the network devices. For more information go to www.profibus.com.

NOTE Failure to terminate a network correctly can seriously affect the operation of the network. If the correct termination networks are not installed, the noise immunity of the network is greatly reduced. Each network segment must be correctly terminated.

4.7 Maximum network length / device loading

The maximum number of devices that can be connected to a single PROFIBUS-DP network segment is 32, this includes all nodes and any repeaters. The maximum lengths of cable for a segment depend on the data rate and are shown in Table 4-2.

Repeaters or fiber optic segments can be used to extend the network, allowing more than 32 nodes to be connected on the network. The maximum number of nodes on a single network is 125.

NOTE For full details on designing and installing a PROFIBUS-DP network, refer to *Installation Guidelines for PROFIBUS-DP/FMS*. This document is available from the PROFIBUS website at www.profibus.com.

Table 4-2 PROFIBUS-DP maximum network cable lengths

Data rate (bits/s)	Maximum trunk length (m)
12M	100
6.0M	100
3.0M	100
1.5M	200
500k	400
187.5k	1000
93.75k	1200
45.45k	1200
19.2k	1200
9.6K	1200

4.8 Node addressing

SI-PROFIBUS has a valid address range of 1 to 125. Addresses 126 and 0 are reserved for system use and should not be used. The addressing scheme used is at the discretion of the end user however it is recommended that nodes are numbered in order as they appear on the physical network. It is not necessary to use consecutive numbers and gaps in the addressing scheme may be left to allow for future expansion.

4.9 Spurs

The PROFIBUS-DP specification allows spurs at data rates less than 1.5 Mb/s. At data rates below 1.5 Mb/s there are specific requirements for capacitance and length of cable allowed when using spurs. Control Techniques recommend that spurs are not used as extreme care is required at the design stage to avoid network problems. More information on spurs can be found on the PROFIBUS website at www.profibus.com.

4.10 Minimum node to node cable length

The minimum recommended node to node distance is one metre of network cable. This distance is necessary to avoid multiple nodes generating a single large reflection on the network, using less than one metre of cable between nodes can have serious implications for network reliability.

4.11 Grounding

Refer to the relevant *Control User Guide* for more information.

5 Getting started

This section is intended to provide a generic guide for configuring SI-PROFIBUS with a master controller. Figure 5-1 is intended as a basic guide, but it does detail the stages that are required to achieve a functioning network. It is recommended that all of this chapter is read, before attempting to configure a system.

NOTE Due to the large number of PLCs/masters that support PROFIBUS-DP, only generic details can be provided. Support is available through your supplier or local Control Techniques Drive Centre.

NOTE Before contacting your supplier or local Control Techniques Drive Centre for support, please read of this manual to check that you have configured all parameters correctly. Before calling, please ensure you have the following information readily to hand:

- A list of all parameters in SI-PROFIBUS.
- The drive firmware version (*see the relevant Control User Guide*).
- The SI-PROFIBUS firmware version.

5.1

Set-up flow chart

Figure 5-1 Set-up flow chart

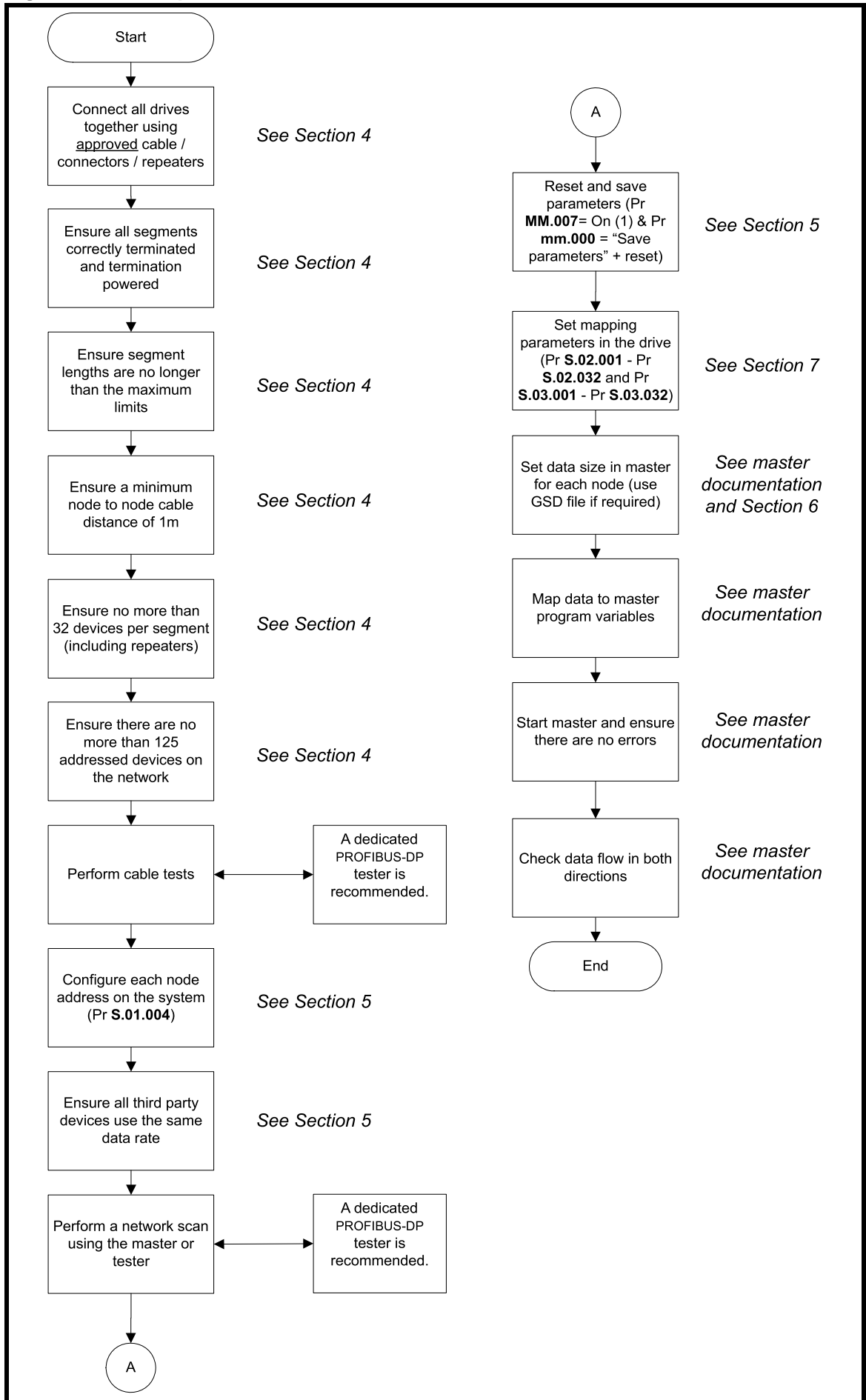

Safety information
Introduction
Mechanical installation
Electrical installation
Getting started
Parameters
GSD Files
Cyclic data
Non-cyclic data
Control and status words
Diagnostics
PROFIdrive profile (V4)
Advanced features
Legacy features
Glossary of terms

5.2 Single line descriptions

5.2.1 Menu 0 - Set-up

Table 5-1 Menu 0 single line descriptions

Parameter		Range(⇅)	Default(⇒)	Type					
S.00.001	Module ID	0 to 65535	443	RO	Num	ND	NC	PT	
S.00.002	Firmware Version	00.00.00.00 to 99.99.99.99		RO	Num	ND	NC	PT	
S.00.003	Hardware Version	00.00 to 99.99		RO	Num	ND	NC	PT	
S.00.004	Serial Number LS	0 to 99999999		RO	Num	ND	NC	PT	
S.00.005	Serial Number MS	0 to 99999999		RO	Num	ND	NC	PT	
S.00.006	Module status	Initializing (0), Ok (1), Config (2), Error (3)		RO	Num	ND	NC	PT	
S.00.007	Module reset	Off (0) or On (1)	Off (0)	RW	Bit		NC		
S.00.008	Module default	Off (0) or On (1)	Off (0)	RW	Bit		NC		

Menu 0 within the option module, is also displayed in the drive menu 15, 16 or 17 depending on which slot the option module is installed to. However, the functionality of all parameters remains the same.

NOTE

Menu 0 is not available in firmware version 01.01.01.02 and previous versions.

5.2.2 Menu 1 - PROFIBUS set-up

Parameter		Range(⇅)	Default(⇒)	Type					
S.01.001	Enable Profibus Interface	Off (0) or On (1)	On (1)	RO	Bit				
S.01.002	Reset Profibus Interface	Off (0) or On (1)	Off (0)	RW	Bit				
S.01.003	Default Profibus Interface	Off (0) or On (1)	Off (0)	RW	Bit				
S.01.004	Profibus node address	0 to 126	126	RW	Num				US
S.01.005	Baud rate	Auto-detect (0), 12 Mbps (1), 6 Mbps (2), 3 Mbps (3), 1.5 Mbps (4), 500 kbps (5), 187.5 kbps (6), 93.75 kbps (7), 45.45 kbps (8), 19.2 kbps (9), 9.6 kbps (10)		RO	Txt	ND	NC	PT	
S.01.006	Profibus Network Diagnostic	Network OK (0), Initialization (1), Initialized(2), No network data (3), First failure (4), Second failure (5), Third Failure (6)		RO	Txt	ND	NC	PT	
S.01.007	Cyclic data transfers per second	0 to 9999 messages/s		RO	Num	ND	NC	PT	
S.01.008	Telegram selection	Auto (0), Custom (1), STD Tel 1 (2), STD Tel 1 + 4 (3), STD Tel 1 + 8 (4), PPO1 (5), PPO2 (6), PPO3 (7), PPO4 (8), PPO5 (9)	Custom (1)	RW	Txt				US

Parameter		Range(⇅)	Default(⇒)	Type					
S.01.010	Timeout delay	0 to 3000 ms	200 ms	RW	Num				US
S.01.011	Timeout action	Trip (0), Send flt values (1), Clear output (2), Hold last (3), No action (4)	Trip (0)	RW	Txt				US
S.01.012	Timeout event destination	This slot (0), Slot 1 (1), Slot 2 (2), Slot 3 (3), Slot 4 (4)	This slot (0)	RW	Txt				US
S.01.013	Timeout event type	No event (0), Event 0 (1), Event 1 (2), Event 2 (3), Event 3 (4), Event 4 (5)	No event (0)	RW	Txt				US
S.01.014	Data alignment	32 (0) or 16 (1) bits	32 (0) bits	RW	Txt				US
S.01.020	Number of Input cyclic words	1 to 32	4	RW	Num		NC	PT	US
S.01.021	Number of Output cyclic words	1 to 32	4	RW	Num		NC	PT	US
S.01.022	Input mapping status	No error (0), Too many IN objs (1), No mapping (2), Read mismatch (3), Hole in mappings (4), N-C mapping err (5), Duplicate error (6), Length mismatch (7), IN mode and PPO (8), Data align w PPO (9), No PPO support (10), SP A-D IN map (11), IN AND CTNC & PPO4 (12)		RO	Txt				
S.01.023	Output mapping status	No error (0), Mapping expected (1), No mapping (2), Write mismatch (3), Hole in mappings (4), N-C mapping err (5), Duplicate error (6), Length mismatch (7), OUT mode and PPO (8), Data align w PPO (9), No PPO support (10), SP A-D OUT map (11), OUT AND CTNC & PPO4 (12)		RO	Txt				
S.01.024	Input processing time	0 to 65535 ms		RO	Num	ND			
S.01.025	Output processing time	0 to 65535 ms		RO	Num	ND			
S.01.026	Input consistency	Off (0) or On (1)	Off (0)	RW	Txt				US
S.01.027	Input consistency trigger	0.00.000 to 4.99.999	0.00.000	RW	Num				US
S.01.028	Output consistency	Off (0) or On (1)	Off (0)	RW	Txt				US
S.01.029	Output consistency trigger	0.00.000 to 4.99.999	0.00.000	RW	Txt				US
S.01.030	Non-cyclic over cyclic	None (0), CTNC (1), PPO defined (2)	None (0)	RW	Txt				US
S.01.031	Compatibility mode	Auto-detect (0), Reserved (1), UniSP (2), UniSP extended (3), Unidrive Classic (4)	Auto-detect (0)	RW	Txt				US

Safety information
Introduction
Mechanical installation
Electrical installation
Getting started
Parameters
GSD Files
Cyclic data
Non-cyclic data
Control and status words
Diagnostics
PROFIdrive profile (V4)
Advanced features
Legacy features
Glossary of terms

5.2.3 Menu 2 - Input mapping

Parameter		Range (⇅)	Default (⇒)	Type					
S.02.001	Input source 1	0 to 5.01.004	0.10.040	RW	Num	DE		PT	US
S.02.002	Input source 2	0 to 5.01.004	0.02.001	RW	Num	DE		PT	US
S.02.003	Input source 3	0 to 5.01.004	0.00.000	RW	Num	DE		PT	US
S.02.004	Input source 4	0 to 5.01.004	0.00.000	RW	Num	DE		PT	US
S.02.005	Input source 5	0 to 5.01.004	0.00.000	RW	Num	DE		PT	US
S.02.006	Input source 6	0 to 5.01.004	0.00.000	RW	Num	DE		PT	US
S.02.007	Input source 7	0 to 5.01.004	0.00.000	RW	Num	DE		PT	US
S.02.008	Input source 8	0 to 5.01.004	0.00.000	RW	Num	DE		PT	US
S.02.009	Input source 9	0 to 5.01.004	0.00.000	RW	Num	DE		PT	US
S.02.010	Input source 10	0 to 5.01.004	0.00.000	RW	Num	DE		PT	US
S.02.011	Input source 11	0 to 5.01.004	0.00.000	RW	Num	DE		PT	US
S.02.012	Input source 12	0 to 5.01.004	0.00.000	RW	Num	DE		PT	US
S.02.013	Input source 13	0 to 5.01.004	0.00.000	RW	Num	DE		PT	US
S.02.014	Input source 14	0 to 5.01.004	0.00.000	RW	Num	DE		PT	US
S.02.015	Input source 15	0 to 5.01.004	0.00.000	RW	Num	DE		PT	US
S.02.016	Input source 16	0 to 5.01.004	0.00.000	RW	Num	DE		PT	US
S.02.017	Input source 17	0 to 5.01.004	0.00.000	RW	Num	DE		PT	US
S.02.018	Input source 18	0 to 5.01.004	0.00.000	RW	Num	DE		PT	US
S.02.019	Input source 19	0 to 5.01.004	0.00.000	RW	Num	DE		PT	US
S.02.020	Input source 20	0 to 5.01.004	0.00.000	RW	Num	DE		PT	US
S.02.021	Input source 21	0 to 5.01.004	0.00.000	RW	Num	DE		PT	US
S.02.022	Input source 22	0 to 5.01.004	0.00.000	RW	Num	DE		PT	US
S.02.023	Input source 23	0 to 5.01.004	0.00.000	RW	Num	DE		PT	US
S.02.024	Input source 24	0 to 5.01.004	0.00.000	RW	Num	DE		PT	US
S.02.025	Input source 25	0 to 5.01.004	0.00.000	RW	Num	DE		PT	US
S.02.026	Input source 26	0 to 5.01.004	0.00.000	RW	Num	DE		PT	US
S.02.027	Input source 27	0 to 5.01.004	0.00.000	RW	Num	DE		PT	US
S.02.028	Input source 28	0 to 5.01.004	0.00.000	RW	Num	DE		PT	US
S.02.029	Input source 29	0 to 5.01.004	0.00.000	RW	Num	DE		PT	US
S.02.030	Input source 30	0 to 5.01.004	0.00.000	RW	Num	DE		PT	US
S.02.031	Input source 31	0 to 5.01.004	0.00.000	RW	Num	DE		PT	US
S.02.032	Input source 32	0 to 5.01.004	0.00.000	RW	Num	DE		PT	US

5.2.4 Menu 3 - Output mapping

Menu		Range(⇅)	Default(⇒)	Type					
S.03.001	Output destination 1	0 to 5.01.004	0.06.042	RW	Num	DE		PT	US
S.03.002	Output destination 2	0 to 5.01.004	0.01.021	RW	Num	DE		PT	US
S.03.003	Output destination 3	0 to 5.01.004	0.00.000	RW	Num	DE		PT	US
S.03.004	Output destination 4	0 to 5.01.004	0.00.000	RW	Num	DE		PT	US
S.03.005	Output destination 5	0 to 5.01.004	0.00.000	RW	Num	DE		PT	US
S.03.006	Output destination 6	0 to 5.01.004	0.00.000	RW	Num	DE		PT	US
S.03.007	Output destination 7	0 to 5.01.004	0.00.000	RW	Num	DE		PT	US
S.03.008	Output destination 8	0 to 5.01.004	0.00.000	RW	Num	DE		PT	US
S.03.009	Output destination 9	0 to 5.01.004	0.00.000	RW	Num	DE		PT	US
S.03.010	Output destination 10	0 to 5.01.004	0.00.000	RW	Num	DE		PT	US
S.03.011	Output destination 11	0 to 5.01.004	0.00.000	RW	Num	DE		PT	US
S.03.012	Output destination 12	0 to 5.01.004	0.00.000	RW	Num	DE		PT	US
S.03.013	Output destination 13	0 to 5.01.004	0.00.000	RW	Num	DE		PT	US
S.03.014	Output destination 14	0 to 5.01.004	0.00.000	RW	Num	DE		PT	US
S.03.015	Output destination 15	0 to 5.01.004	0.00.000	RW	Num	DE		PT	US
S.03.016	Output destination 16	0 to 5.01.004	0.00.000	RW	Num	DE		PT	US
S.03.017	Output destination 17	0 to 5.01.004	0.00.000	RW	Num	DE		PT	US
S.03.018	Output destination 18	0 to 5.01.004	0.00.000	RW	Num	DE		PT	US
S.03.019	Output destination 19	0 to 5.01.004	0.00.000	RW	Num	DE		PT	US
S.03.020	Output destination 20	0 to 5.01.004	0.00.000	RW	Num	DE		PT	US
S.03.021	Output destination 21	0 to 5.01.004	0.00.000	RW	Num	DE		PT	US
S.03.022	Output destination 22	0 to 5.01.004	0.00.000	RW	Num	DE		PT	US
S.03.023	Output destination 23	0 to 5.01.004	0.00.000	RW	Num	DE		PT	US
S.03.024	Output destination 24	0 to 5.01.004	0.00.000	RW	Num	DE		PT	US
S.03.025	Output destination 25	0 to 5.01.004	0.00.000	RW	Num	DE		PT	US
S.03.026	Output destination 26	0 to 5.01.004	0.00.000	RW	Num	DE		PT	US
S.03.027	Output destination 27	0 to 5.01.004	0.00.000	RW	Num	DE		PT	US
S.03.028	Output destination 28	0 to 5.01.004	0.00.000	RW	Num	DE		PT	US
S.03.029	Output destination 29	0 to 5.01.004	0.00.000	RW	Num	DE		PT	US
S.03.030	Output destination 30	0 to 5.01.004	0.00.000	RW	Num	DE		PT	US
S.03.031	Output destination 31	0 to 5.01.004	0.00.000	RW	Num	DE		PT	US
S.03.032	Output destination 32	0 to 5.01.004	0.00.000	RW	Num	DE		PT	US

Safety information
Introduction
Mechanical installation
Electrical installation
Getting started
Parameters
GSD Files
Cyclic data
Non-cyclic data
Control and status words
Diagnostics
PROFIdrive profile (V4)
Advanced features
Legacy features
Glossary of terms

5.2.5 Menu 4 - Fault values

Parameter		Range(⇅)	Default(⇔)	Type					
S.04.001	Fault value 1	-2^{31} to $2^{31}-1$	0	RW	Num				US
S.04.002	Fault value 2	-2^{31} to $2^{31}-1$	0	RW	Num				US
S.04.003	Fault value 3	-2^{31} to $2^{31}-1$	0	RW	Num				US
S.04.004	Fault value 4	-2^{31} to $2^{31}-1$	0	RW	Num				US
S.04.005	Fault value 5	-2^{31} to $2^{31}-1$	0	RW	Num				US
S.04.006	Fault value 6	-2^{31} to $2^{31}-1$	0	RW	Num				US
S.04.007	Fault value 7	-2^{31} to $2^{31}-1$	0	RW	Num				US
S.04.008	Fault value 8	-2^{31} to $2^{31}-1$	0	RW	Num				US
S.04.009	Fault value 9	-2^{31} to $2^{31}-1$	0	RW	Num				US
S.04.010	Fault value 10	-2^{31} to $2^{31}-1$	0	RW	Num				US
S.04.011	Fault value 11	-2^{31} to $2^{31}-1$	0	RW	Num				US
S.04.012	Fault value 12	-2^{31} to $2^{31}-1$	0	RW	Num				US
S.04.013	Fault value 13	-2^{31} to $2^{31}-1$	0	RW	Num				US
S.04.014	Fault value 14	-2^{31} to $2^{31}-1$	0	RW	Num				US
S.04.015	Fault value 15	-2^{31} to $2^{31}-1$	0	RW	Num				US
S.04.016	Fault value 16	-2^{31} to $2^{31}-1$	0	RW	Num				US
S.04.017	Fault value 17	-2^{31} to $2^{31}-1$	0	RW	Num				US
S.04.018	Fault value 18	-2^{31} to $2^{31}-1$	0	RW	Num				US
S.04.019	Fault value 19	-2^{31} to $2^{31}-1$	0	RW	Num				US
S.04.020	Fault value 20	-2^{31} to $2^{31}-1$	0	RW	Num				US
S.04.021	Fault value 21	-2^{31} to $2^{31}-1$	0	RW	Num				US
S.04.022	Fault value 22	-2^{31} to $2^{31}-1$	0	RW	Num				US
S.04.023	Fault value 23	-2^{31} to $2^{31}-1$	0	RW	Num				US
S.04.024	Fault value 24	-2^{31} to $2^{31}-1$	0	RW	Num				US
S.04.025	Fault value 25	-2^{31} to $2^{31}-1$	0	RW	Num				US
S.04.026	Fault value 26	-2^{31} to $2^{31}-1$	0	RW	Num				US
S.04.027	Fault value 27	-2^{31} to $2^{31}-1$	0	RW	Num				US
S.04.028	Fault value 28	-2^{31} to $2^{31}-1$	0	RW	Num				US
S.04.029	Fault value 29	-2^{31} to $2^{31}-1$	0	RW	Num				US

Parameter		Range(⇅)	Default(⇨)	Type						
S.04.030	Fault value 30	-2^{31} to $2^{31}-1$	0	RW	Num					US
S.04.031	Fault value 31	-2^{31} to $2^{31}-1$	0	RW	Num					US
S.04.032	Fault value 32	-2^{31} to $2^{31}-1$	0	RW	Num					US

5.2.6 Menu 9 resources

Parameter		Range	Default						
S.09.030	PCB temperature 1	-128 °C to 127 °C		RO	Num	ND	NC	PT	
S.09.031	PCB temperature 2	-128 °C to 127 °C		RO	Num	ND	NC	PT	

Safety information
Introduction
Mechanical installation
Electrical installation
Getting started
Parameters
GSD Files
Cyclic data
Non-cyclic data
Control and status words
Diagnostics
PROFIdrive profile (V4)
Advanced features
Legacy features
Glossary of terms

6 Parameters

6.1 Menus

Table 6-1 SI-PROFIBUS internal menus

Menu	Description
S.0	Module information
S.1	PROFIBUS set-up
S.2	Input mapping
S.3	Output mapping
S.4	Fault values
S.9	Resources

S is the slot number where the module is installed.

The module's menu 0 is also displayed in menu 15, 16 or 17 depending on which slot the module is installed to. Table 6-2 below shows the location of the module's menu 0 on the drive.

NOTE

Menu 0 is not available in firmware version 01.01.01.02 and previous versions.

NOTE

For M200, M300 and M400 drives, the module menu 0 will be displayed in drive menu 15.

Table 6-2 SI-PROFIBUS menu 0 locations on M700/M800.

Slot number	Menu 0 locations
1	15
2	16
3	17

6.2 Module menu 0 - module information

Module ID Code		
S.00.001	Default	443
	Range	0 to 999
	Access	RO
SI-PROFIBUS firmware version		
S.00.002	Default	N/A
	Range	00.00.00.00 to 99.99.99.99
	Access	RO

The firmware version of the option module is in the format of **ww.xx.yy.zz**.

SI-PROFIBUS hardware version		
S.00.003	Default	N/A
	Range	00.00 to 99.99
	Access	RO

The hardware version of the option module is in the format of **yy.zz**.

Serial number LS		
S.00.004	Default	N/A
	Range	0 to 99999999
	Access	RO

Serial number MS		
S.00.005	Default	N/A
	Range	0 to 99999999
	Access	RO

The module serial number is available as a pair of 32-bit values where Serial Number LS (Pr **S.00.004**) provides the least significant 8 decimal digits, and Serial Number MS (Pr **S.00.005**) provides the most significant 8 decimal digits. The reconstructed serial number is $((\mathbf{S.00.005} \times 10000000) + \mathbf{S.00.004})$. For example, serial number "0001234567898765" would be stored as Pr **S.00.005** = 12345 and Pr **S.00.004** = 67898765.

Module status		
S.00.006	Default	N/A
	Range	0 to 99999999
	Access	RO

This parameter displays the current status of the module. All possible values are shown in the table below.

Value	Text	Description
0	Initializing	Module is currently initializing
1	OK	Module has initialized and has found no errors.
2	Config	A configuration error has been detected in one of the communications protocols or user program.
3	Error	An error has occurred preventing the firmware or user program running correctly.

Reset module		
S.00.007	Default	Off (0)
	Range	Off (0) or On (1)
	Access	RW

Changes to the SI-PROFIBUS configuration will not take effect until the SI-PROFIBUS has been reset.

To reset the SI-PROFIBUS:

- Set Pr **S.00.007** to On (1).
- When the sequence has been completed, Pr **S.00.007** will be reset to Off (0).
- The SI-PROFIBUS will reset using the updated configuration.

NOTE

This sequence does NOT store the SI-PROFIBUS configuration parameters in the drive or the SI-PROFIBUS flash memory. This parameter will change back to Off (0) immediately and as such the change may not be visible on the display.

Default module		
S.00.008	Default	Off (0)
	Range	Off (0) or On (1)
	Access	RW

The SI-PROFIBUS option module can be set to it's factory default configuration.

This can be performed as follows:

- Set Pr **S.00.008** to On (1).
- Reset the module by setting Pr **S.00.007** to On (1).
- SI-PROFIBUS communications will be stopped.
- Default parameter values for the SI-PROFIBUS will be loaded.
- The SI-PROFIBUS will reset using the default values.

NOTE

If the host drive is defaulted (see the *Control User Guide* for details), it will also clear the current configuration for the slot SI-PROFIBUS is installed to.

6.3 Module menu 1 - PROFIBUS Set-up

Menu 1 contains all the parameters relating to the set-up of the PROFIBUS interface on the SI-PROFIBUS module.

Enable PROFIBUS interface		
S.01.001	Default	On (1)
	Range	OFF (0) or On (1)
	Access	RO

This parameter displays a value of On (1) to indicate that the PROFIBUS Interface has been enabled.

Reset PROFIBUS interface		
S.01.002	Default	OFF (0)
	Range	OFF (0) or On (1)
	Access	RW

Changes to the SI-PROFIBUS configuration will not take effect until the SI-PROFIBUS has been reset.

To reset the SI-PROFIBUS:

- Set Pr **S.01.002** to On (1).
- When the sequence has been completed, Pr **S.01.002** will be reset to OFF (0).
- The SI-PROFIBUS will reset using the updated configuration.

NOTE

This sequence does NOT store the SI-PROFIBUS configuration parameters in the drive or the SI-PROFIBUS flash memory. This parameter will change back to OFF immediately, and as such the change may not be visible in the display.

Default PROFIBUS Interface		
S.01.003	Default	OFF (0)
	Range	OFF (0) or On (1)
	Access	RW

The SI-PROFIBUS option module can be set to it's factory default configuration.

This can be performed as follows:

- Set Pr **S.01.003** to On
- Reset the PROFIBUS interface by setting Pr **S.01.002** to On (1).
- SI-PROFIBUS communications will be stopped
- The host drive will load and store its default parameter values
- Default parameter values for the SI-PROFIBUS will be loaded
- The SI-PROFIBUS will reset using the default values

NOTE

If the host drive is defaulted (see the relevant *Control User Guide* for details), it will also clear the current configuration for the slot SI-PROFIBUS is installed to.

Safety information
Introduction
Mechanical installation
Electrical installation
Getting started
Parameters
GSD Files
Cyclic data
Non-cyclic data
Control and status words
Diagnostics
PROFIdrive profile (V/4)
Advanced features
Legacy features
Glossary of terms

SI-PROFIBUS node address		
S.01.004	Default	126
	Range	0 to 126
	Access	RW

Every node on a PROFIBUS-DP network must be given a unique network node address. To activate a change in the node address value, the SI-PROFIBUS must be reset (Pr S.01.002 or MM.007 = On). Addresses 0 and 126 are reserved for system use.

Network baud rate		
S.01.005	Default	N/A
	Range	0 to 10
	Access	RO

The SI-PROFIBUS will automatically detect the PROFIBUS-DP network data rate and synchronize to it. Pr S.01.005 will indicate the data rate that has been detected by the SI-PROFIBUS.

A value of 0 indicates that the SI-PROFIBUS has not detected any activity on the PROFIBUS-DP network, and is waiting for the master controller to start communicating.

NOTE

The PROFIBUS-DP data rate parameter can be changed, but this will not affect the data rate at which the SI-PROFIBUS communicates. The data rate display will be updated when the SI-PROFIBUS is reset.

Table 6-3 SI-PROFIBUS data rates

Pr S.01.005	Bits/s	PROFIdrive PNU963
0	Auto-detecting	N/A
1	12 M	9
2	6.0 M	8
3	3.0 M	7
4	1.5 M	6
5	500 k	4
6	187.5 k	3
7	93.75 k	2
8	45.45 k	11
9	19.2 k	1
10	9.6 k	0

SI-PROFIBUS network diagnostic		
S.01.006	Default	N/A
	Range	0 to 6
	Access	RO

SI-PROFIBUS cyclic data rate		
S.01.007	Default	N/A
	Range	0 to 9999 Messages/s
	Access	RO

The PROFIBUS-DP network activity can be monitored in the SI-PROFIBUS operating status parameter, Pr **S.01.006**. When the SI-PROFIBUS is in data exchange with the PROFIBUS-DP master controller, Pr **S.01.007** will give an indication of the number of cyclic data messages that are being processed per second. All possible values of **S.01.006** are given in Table 6-4.

Table 6-4 SI-PROFIBUS network diagnostics (S.01.006)

Value	Text	Description
0	Network OK	Network OK/healthy.
1	Intilaization	A part of the SI-PROFIBUS initialization sequence was not successful. If this fault persists after a power-cycle, replace the SI-PROFIBUS. This error may also occur if the PROFIBUS-DP master is not connected.
2	Initialized	The SI-PROFIBUS has initialized correctly and is waiting for the Profibus-DP master to initialise communications. This error may also occur if the PROFIBUS-DP master connection is removed.
3	Network no data	Network OK/healthy but no network cycles per second detected.
4	First Failure	Mapping configuration fail when mappings are set by input mapping menu and output mapping menu (S.01.008 > 0) or ASCII configuration fail when mappings are set by GSD files (S.01.008 = 0).
5	Second Failure	Mapping configuration fail when mappings are set by GSD files (S.01.008 = 0) or ASCII configuration fail when mappings are set by input mapping menu and output mapping menu (S.01.008 > 0).
6	Third Failure	SI-PROFIBUS does not support CTNC or PPO4 (S.01.030 = 1 or 2), and does not support ProfiDrive V2 (S.01.008 > 2).

Telegram selection		
S.01.008	Default	1
	Range	0 to 9
	Access	RW

If the telegram selection (Pr **S.01.008**) = Auto (0), the number of input and output cyclic words and the input and output mappings are set by the PLC master on the network. The mapping configuration parameters can still be changed on the keypad but when the module or PLC is reset or power-cycled, the PLC will set them up as originally configured.

If the telegram selection (Pr **S.01.008**) = Custom (1), the number of input and output cyclic words and the input and output mappings are set by the user.

If the telegram selection (Pr **S.01.008**) = STD Tel 1 (2), the number of input and output cyclic words and the input and output mappings are set by the PROFIdrive parameters.

The mapping configuration parameters can still be changed on the keypad but when the module is reset or power-cycled, the module will set them according to the selected telegram (Pr **S.01.008**).

The input mappings are PNU968 and PNU1001 and the output mappings are PNU967 and PNU1003.

Pr **S.02.001** will display 5.00.968 (PNU968), Pr **S.02.002** will display 5.01.001 (PNU1001), Pr **S.03.001** will display 5.00.967 (PNU967) and Pr **S.03.002** will display 5.01.003 (PNU1003).

Table 6-5 shows all the possible values of the Telegram selection (Pr **S.01.008**).

Table 6-5 All values for Telegram selection

Value	Text	Description
0	Auto	Mappings set by PLC
1	Custom	Mappings set by drive
2	STD Tel 1	Fixed mappings
3	STD Tel 1 + 4	SP compatibility mode only. 6 cyclic words (4 words user mappable)
4	STD Tel 1 + 8	SP compatibility mode only. 10 cyclic words (8 words user mappable)
5	PPO1	SP compatibility mode only. 4 words non-cyclic, 2 words cyclic
6	PPO2	SP compatibility mode only. 4 words non-cyclic, 6 words cyclic
7	PPO3	SP compatibility mode only. 2 words cyclic
8	PPO4	SP compatibility mode only. 6 words cyclic
9	PPO5	SP compatibility mode only. 4 words non-cyclic, 10 words cyclic

As shown in Table 6-5, only Auto, Custom and STD Tel 1 are available when the SI-PROFIBUS module is connected to a Unidrive M and compatibility mode (Pr **S.01.031**) is set to Auto detect. If any other telegram selection is made, the drive will display an alarm of Invalid IN map and Invalid OUT map (see Chapter 11 *Diagnostics* on page 61 for more information).

See Chapter 14 *Legacy features* on page 79 for more information on the full range of Telegram selection (Pr **S.01.008**) when in Unidrive SP compatibility mode.

Network loss selection		
S.01.010	Default	200 ms
	Range	0 to 3000 ms
	Access	RW

The network loss detection feature provides a method which detects whether the communication to the master is still present. The SI-PROFIBUS resets an internal timer when a valid message is received from the SI-PROFIBUS network, if a message is not received within the specified period, network loss is detected.

The network loss detection can be disabled by setting the value of Pr **S.01.010** to 0. Users must then take adequate precautions in the event of a failure of the PROFIBUS network.

NOTE

Network loss detection is not enabled internally until cyclic data has been detected. This prevents spurious network loss timeouts while the SI-PROFIBUS master controller is initializing the PROFIBUS-DP network.

Timeout action		
S.01.011	Default	Trip (0)
	Range	Trip (0) to No action (4)
	Access	RW

Pr **S.01.011** determines the action to take when a timeout specified by Pr **S.01.010** occurs. All possible actions and descriptions are listed below.

Value	Text	Description
0	Trip	Trip the drive
1	Send flt values	Send fault values to output parameters
2	Clear output	PLC output parameters will have values set to zero
3	Hold last	Hold the last value in the PLC output parameters
4	No action	No action with output parameters

When a value of "Trip" is selected in Pr **S.01.011** and no cyclic communications have been detected in a time period defined by Pr **S.01.010** then the drive will trip displaying "SlotX Error" with a sub-trip string of "Link loss".

If the network loss timeout time (Pr **S.01.010**) is reduced too far, spurious network losses may occur due to a time-out occurring before the time period under normal operating conditions.



Network loss detection can be disabled by setting Pr **S.01.010** to 0. It is the user's responsibility to ensure that adequate safety precautions are taken to prevent damage or injury by disabling the drive in the event of a loss of communications.

If Pr **S.01.011** is set to "Send flt values", the fault values entered in Pr **S.04.001** to Pr **S.04.032** are sent to the mapped output parameters when a network timeout error occurs. If a valid PROFIBUS message is subsequently detected then the PLC output values will be written as normal

e.g. if Pr **S.03.001** = 20021 and Pr **S.03.002** = 20022 and a timeout error occurs, the value in Pr **S.04.001** will be sent to Pr **20.021** and the value in Pr **S.04.002** will be sent to Pr **20.022** as defined in the out mapping parameters.

If Pr **S.01.011** is set to "Clear output", all PLC output parameter values are set to zero in the event of a network loss timeout occurring.

e.g. if Pr **S.03.001** = 20021 and Pr **S.03.002** = 20022 and a timeout error occurs, Pr **20.021** and Pr **20.022** will be set to 0.

If Pr **S.01.011** is set to "Hold last", the last values sent by the PLC are held in the mapped output parameters in the event of a network loss timeout occurring.

e.g. if Pr **S.03.001** = 20021 and Pr **S.03.002** = 20022 and a timeout error occurs, Pr **20.021** and Pr **20.022** will equal the last values sent by the PLC.

If Pr **S.01.011** is set to "No action", then the module will not write any value to any mapped output parameters.

Timeout event destination		
S.01.012	Default	This Slot (0)
	Range	This Slot (0) to Slot4 (4)
	Access	RW

Timeout event type		
S.01.013	Default	No Event (0)
	Range	No Event (0) to Event4 (4)
	Access	RW

When a timeout occurs, the SI-PROFIBUS module can trigger an event defined by Pr **S.01.013** to a destination, such as an option module installed to a different slot on the drive, defined by Pr **S.01.012**.

NOTE

This feature is not yet implemented.

NOTE

If triggering an event to a different option module, Pr **S.01.012** must point to a slot where a compatible option module is installed to.

Cyclic data alignment		
S.01.014	Default	32 (0)
	Range	32 (0) or 16 (1) bits
	Access	RW

By default, the SI-PROFIBUS uses 32 bits for each data channel, even if the target parameter in the drive is a 16-bit parameter. This strategy (known as casting), ensures that the cyclic data transmitted over the SI-PROFIBUS network remains aligned with the memory locations in 32-bit PLC's. When cyclic data alignment (Pr **S.01.014**) is set to "16 bits", a data channel will only use 32 bits if the target drive parameter is a 32-bit parameter. If the target drive parameter is only 1, 8 or 16 bits wide, 16 bits will be used for that particular data channel as shown in the following table.

Parameter size (bits)	Actual data size (bits) Alignment = 16 bits	Actual data size (bits) Alignment = 32 bits
1	16	32
8		
16		
32	32	

The following examples demonstrate setting up a network using five cyclic channels for both IN and OUT data with the cyclic data alignment first set to 32 bits and then set to 16 bits.

Table 6-6 shows the mapping parameters where five IN and five OUT cyclic data channels are required. With data alignment set to 32 bits, each data channel uses 32 bits (two data words, so a total of ten words are required).

Table 6-6 Mapping parameters

Data channel	Data words used	Mapping for slot 3	Setting	Data width (bits)	Mapping status
IN channel 1	IN word 0, 1	Pr 3.02.001	0.10.040	16	Pr 10.040 , status word
IN channel 2	IN word 2, 3	Pr 3.02.002	0.02.001	32	Pr 02.001 , post-ramp speed reference
IN channel 3	IN word 4, 5	Pr 3.02.003	0.04.020	16	Pr 04.020 , Motor load as % of rated motor load
IN channel 4	IN word 6, 7	Pr 3.02.004	0.14.021	16	Pr 14.021 , PID1 feedback
IN channel 5	IN word 8, 9	Pr 3.02.005	0.14.001	16	Pr 14.001 , PID1 output
OUT channel 1	OUT word 0, 1	Pr 3.03.001	0.06.042	16	Pr 06.042 , control word
OUT channel 2	OUT word 2, 3	Pr 3.03.002	0.01.021	32	Pr 01.021 , preset reference 1
OUT channel 3	OUT word 4, 5	Pr 3.03.003	0.02.011	32	Pr 02.011 , acceleration rate 1
OUT channel 4	OUT word 6, 7	Pr 3.03.004	0.02.021	32	Pr 02.021 , deceleration rate 1
OUT channel 5	OUT word 8, 9	Pr 3.03.005	0.14.020	16	Pr 14.020 , PID1 reference

It is advisable to keep 16-bit parameters paired together. This prevents mis-alignment of cyclic data with 32-bit PLC registers when using auto-mapping facilities to configure the SI-PROFIBUS network. By swapping the mappings for input channel 2 with input channel 3, and moving output channel 5 to output channel 2, the data channel structure will appear as shown in the table below.

Data channel	Data words used	Mapping for slot 3	Setting	Data width (bits)	Mapping status
IN channel 1	IN word 0	Pr 3.02.001	0.10.040	16	Pr 10.040 , status word
IN channel 2	IN word 1	Pr 3.02.002	0.04.020	16	Pr 04.020 , Motor load as % of rated motor load
IN channel 3	IN word 2, 3	Pr 3.02.003	0.02.001	32	Pr 02.001 , post-ramp speed reference
IN channel 4	IN word 4	Pr 3.02.004	0.14.021	16	Pr 14.021 , PID1 feedback
IN channel 5	IN word 5	Pr 3.02.005	0.14.001	16	Pr 14.001 , PID1 output
OUT channel 1	OUT word 0	Pr 3.03.001	0.06.042	16	Pr 06.042 , control word
OUT channel 2	OUT word 1	Pr 3.03.002	0.14.020	16	Pr 14.020 , PID1 reference
OUT channel 3	OUT word 2, 3	Pr 3.03.003	0.01.021	32	Pr 01.021 , preset reference 1
OUT channel 4	OUT word 4, 5	Pr 3.03.004	0.02.011	32	Pr 02.011 , acceleration rate
OUT channel 5	OUT word 6, 7	Pr 3.03.005	0.02.021	32	Pr 02.021 , deceleration rate 1

Safety information
Introduction
Mechanical installation
Electrical installation
Getting started
Parameters
GSD Files
Cyclic data
Non-cyclic data
Control and status words
Diagnostics
PROFIdrive profile (V4)
Advanced features
Legacy features
Glossary of terms

Input cyclic words		
S.01.020	Default	4
	Range	1 to 32
	Access	RW

Output cyclic words		
S.01.021	Default	4
	Range	1 to 32
	Access	RW

If the telegram selection (Pr **S.01.008**) = Auto (0), the number of input and output cyclic words and the input and output mappings are set by the PLC master on the network. The mapping configuration parameters can still be changed on the keypad but when the module or PLC is reset or power-cycled, the PLC will set them up as originally configured.

If the telegram selection (Pr **S.01.008**) = Custom (1), the number of input and output cyclic words and the input and output mappings are set by the user.

If the telegram selection (Pr **S.01.008**) = STD Tel 1 (2), the number of input and output cyclic words and the input and output mappings are set by the PROFIdrive parameters.

The mapping configuration parameters can still be changed on the keypad but when the module is reset or power-cycled, the module will set them according to the selected telegram (Pr **S.01.008**).

The input mappings are PNU968 and PNU1001 and the output mappings are PNU967 and PNU1003. Pr **S.02.001** will display 5.00.968 (PNU968), Pr **S.02.002** will display 5.01.001 (PNU1001), Pr **S.03.001** will display 5.00.967 (PNU967) and Pr **S.03.002** will display 5.01.003 (PNU1003).

Input mapping status		
S.01.022	Default	0
	Range	0 to 12
	Access	RW

Output mapping status		
S.01.023	Default	0
	Range	0 to 12
	Access	RW

If the SI-PROFIBUS network diagnostic parameter (Pr **S.01.006**) indicates "First Failure" or "Second Failure", a mapping configuration error has been detected. The reason for the error is indicated by the SI-PROFIBUS input mapping status parameter (Pr **S.01.022**) and the SI-PROFIBUS output mapping status parameter (Pr **S.01.023**).

When a mapping error has been corrected, reset the SI-PROFIBUS module by setting Pr **S.01.002** or **MM.007** to On (1).

The input mapping error codes are described in Table 6-7 on page 39 and the output mapping error codes are described in Table 6-8 on page 39.

Table 6-7 Input mapping error codes

Value	Text	Description
0	No error	No error detected with IN cyclic data mapping configuration
1	Too many IN objs	Too many IN channels configured
2	No mapping	IN cyclic data length is 0 or there is no IN mapping.
3	Read mismatch	Parameter read error (parameter may not exist)
4	Hole in mappings	IN cyclic data mapping parameters are not contiguous
5	N-C mapping err	A non-cyclic data mode has been mapped more than once in the IN data mapping configuration parameters
6	Duplicate error	Two or more IN cyclic data mapping configuration parameters have been configured with the same destination parameter reference
7	Length mismatch	Mismatch in data length
8	IN MODE AND PPO	Non-cyclic and PPO STD Tel 1 both exist
9	Data align w PPO	Can't configure PPO when data alignment is set to 32 bits
10	No PPO support	PPO1-PPO5 not supported
11	SP A-D IN map	Input Mapping can't be set by GSD file automatically in SP mode
12	IN AND CTNC PPO4	CTNC and PPO4 not supported

Table 6-8 Output mapping error codes

Value	Text	Description
0	No error	No error detected with OUT cyclic data mapping configuration.
1	Mapping exceeded	Too many OUT channels configured
2	No mapping	OUT cyclic data length is 0 or there is no OUT mapping.
3	Write mismatch	Parameter write error (parameter may not exist or might be read-only)
4	Hole in mappings	OUT data mapping parameters are not contiguous
5	N-C mapping err	A non-cyclic data mode has been mapped more than once in the OUT data mapping configuration parameters
6	Duplicate error	Two or more OUT cyclic data mapping configuration parameters have been configured with the same destination parameter reference
7	Length mismatch	Mismatch in data length
8	OUT MODE AND PPO	Non-cyclic and PPO STD Tel 1 both exist
9	Data align w PPO	Can't configure PPO when data alignment is set to 32 bits
10	No PPO support	PPO1-PPO5 not supported
11	SP A-D OUT map	Output Mapping can't be set by GSD file automatically in SP mode
12	OUT AND CTNC PPO4	CTNC and PPO4 not supported

Safety information
Introduction
Mechanical installation
Electrical installation
Getting started
Parameters
GSD Files
Cyclic data
Non-cyclic data
Control and status words
Diagnostics
PROFdrive profile (V4)
Advanced features
Legacy features
Glossary of terms

Input processing time		
S.01.024	Default	N/A
	Range	0 to 65535
	Access	RO

Output processing time		
S.01.025	Default	N/A
	Range	0 to 65535
	Access	RW

Pr **S.01.024** and Pr **S.01.025** display the input and output processing times respectively. The input processing time (Pr **S.01.024**) shows the time taken from the value being sent from the drive to the value being written to the master controller in milliseconds. The output processing time (Pr **S.01.025**) shows the time taken from the value being sent from the master controller to the value being successfully written to the drive in milliseconds.

Input consistency action		
S.01.026	Default	OFF (0)
	Range	OFF (0) or On (1)
	Access	RW

Input consistency trigger parameter		
S.01.027	Default	N/A
	Range	0.00.000 to 4.99.999
	Access	RW

Output consistency action		
S.01.028	Default	OFF (0)
	Range	OFF (0) or On (1)
	Access	RW

Output consistency trigger parameter		
S.01.029	Default	N/A
	Range	0.00.000 to 4.99.999
	Access	RW

The SI-PROFIBUS module provides an input/output consistency feature which ensures that the data in the input or output mappings is only transferred between the SI-PROFIBUS module and the master controller when the mapped parameters are ready. This prevents data skew between parameters in the input/output mappings.

If input consistency action (Pr **S.01.026**) and output consistency action (Pr **S.01.028**) are set to 0 (i.e. default settings), then the input/output consistency features are disabled so that input and output data is always transferred between the master controller and the drive.

If input consistency action (Pr **S.01.026**) is set to On (1), the SI-PROFIBUS module will check the value of the parameter specified by the input consistency trigger parameter (Pr **S.01.027**). If the input consistency trigger parameter defined by Pr **S.01.027** is set to a non-zero value (for example by a user program in an applications module), this indicates to the SI-PROFIBUS module that all the mapped parameters are ready to be read. The module will then read the mapped parameters, transfer them to the PLC and will then clear the input consistency trigger parameter to zero. When the input trigger source parameter is set to zero, the SI-PROFIBUS module will continue to transfer the input consistency trigger parameter previously read data to the PLC.

If output consistency action (Pr **S.01.028**) is set to On (1), the SI-PROFIBUS module will check the value of the parameter specified by the output consistency trigger parameter (Pr **S.01.029**). The output consistency trigger parameter defined by Pr **S.01.029** will initially be set to 1.

If the output consistency trigger parameter is set to zero (for example by a user program in an applications module), this indicates to the SI-PROFIBUS module that all the mapped parameters are ready to be written to. The module will then write the data from the master controller into the mapped parameters, and will then set the output trigger source parameter to 1. When the output consistency trigger parameter is set to 1, it indicates to the SI-PROFIBUS module that the mapped parameters are not ready to be written to, and therefore any new data from the master controller will not be written to the mapped parameters in the drive until the output consistency trigger parameter is again set to zero.

Non-cyclic over cyclic		
S.01.030	Default	None (0)
	Range	None (0) to PPO defined (2)
	Access	RW

Sending non-cyclic data over the cyclic channel can only be accomplished when the SI-PROFIBUS module is set up for a Unidrive SP in compatibility mode (Pr **S.01.031** = “UniSP” or “UniSP extended”) and the correct GSD file used for the simulated drive (e.g. SP_0672.GSD).

The term 'non-cyclic over cyclic' is used to refer to non-cyclic data which is transmitted as part of the cyclic data and not using the non-cyclic DP-V1 channel.

The table below shows how to configure the non-cyclic over cyclic parameter (Pr **S.01.030**) for the required non-cyclic mode.

Table 6-9 Non-cyclic over cyclic modes

Value	Text	Description
0		
1	CTNC	1 Non-cyclic word (CT Single Word mode 1)
2	PPO defined	4 Non-cyclic words (PPO 4 Word mode 2)

For more information on sending / receiving non-cyclic data see section 9 *Non-cyclic data* on page 53.

Network compatibility mode		
S.01.031	Default	Auto detect (0)
	Range	Auto detect (0) to Unidrive Classic (4)
	Access	RW

SI-PROFIBUS provides a compatibility mode as standard.

Pr **S.01.031** can be used to select which drive the SI-PROFIBUS module is to appear as on the PROFIBUS network, this only applies to the network identification and not the drive functionality.

Table 6-10 Compatibility mode settings

Value	Text	Description
0	Auto detect	Auto detect
1	Reserved	Reserved for future use
2	UniSP	Unidrive SP mode
3	UniSP extended	Unidrive SP mode with extended diagnostics support
4	Unidrive Classic	Unidrive Classic mode

Using the compatibility mode allows the replacement of drives on a PROFIBUS-DP network, without having to make any changes to the master controller network configuration, it changes the identity code of the module so that the master controller believes that a similar type of drive is present for a particular node.

NOTE

When using compatibility mode, ensure that the correct GSD file for the simulated drive is being used and not the actual drive.



This mode only changes the network to emulate the selected drive on the network. Changes to the control method and data size differences must still be considered. This mode does NOT allow direct replacement.

When using extended diagnostics (Pr **S.01.031** = 3), the appropriate GSD file using the correct PROFIBUS identification code (0x0B4F) must be used (e.g. 'SP__0B4F.GSD For GSD file compatibility, please refer to Table 7-1 *Selecting the correct GSD file* on page 48.

When the compatibility mode is set to "Auto detect", the SI-PROFIBUS module will return the actual drive PROFIBUS ID code.

As of firmware V01.02.00.02 two PROFIBUS ID codes are used for Unidrive M, UniM 200/300/400 uses ID code 0EA5 and UniM 700/800 uses ID code ODB8, this means there are two GSD files for Unidrive M and users must ensure the correct file is used for the selected drive. Previously only one ID code (ODB8) and therefore one GSD file was used for all Unidrive M drives.

NOTE

Unidrive M200/M300/M400 are not supported in versions V01.02.00.02 or earlier.

NOTE

If the 'Reserved' option is selected, then the module will operate in "Auto detect" mode.

6.4 Module menu 2 - Input mapping

Menu 2 contains all the mapping parameters relating to the IN channels of the module.

The values set in each parameter are in the format of **S.mm.ppp** where:

S = slot number of the source parameter

mm = menu number of the source parameter

ppp = parameter number of the source parameter

IN channel	Mapping parameter	Default value
1	Pr S.02.001	0.10.040
2	Pr S.02.002	0.02.001
3	Pr S.02.003	0.00.000
4	Pr S.02.004	0.00.000
5	Pr S.02.005	0.00.000
6	Pr S.02.006	0.00.000
7	Pr S.02.007	0.00.000
8	Pr S.02.008	0.00.000
9	Pr S.02.009	0.00.000
10	Pr S.02.010	0.00.000
11	Pr S.02.011	0.00.000
12	Pr S.02.012	0.00.000
13	Pr S.02.013	0.00.000
14	Pr S.02.014	0.00.000
15	Pr S.02.015	0.00.000
16	Pr S.02.016	0.00.000
17	Pr S.02.017	0.00.000
18	Pr S.02.018	0.00.000
19	Pr S.02.019	0.00.000
20	Pr S.02.020	0.00.000
21	Pr S.02.021	0.00.000
22	Pr S.02.022	0.00.000
23	Pr S.02.023	0.00.000
24	Pr S.02.024	0.00.000
25	Pr S.02.025	0.00.000
26	Pr S.02.026	0.00.000
27	Pr S.02.027	0.00.000
28	Pr S.02.028	0.00.000
29	Pr S.02.029	0.00.000
30	Pr S.02.030	0.00.000
31	Pr S.02.031	0.00.000
32	Pr S.02.032	0.00.000

Safety information
Introduction
Mechanical installation
Electrical installation
Getting started
Parameters
GSD Files
Cyclic data
Non-cyclic data
Control and status words
Diagnostics
PROFIdrive profile (V4)
Advanced features
Legacy features
Glossary of terms

6.5 Module menu 3 - Output mapping

Menu 3 contains all the mapping parameters relating to the OUT channels of the module.

The values set in each parameter are in the format of **S.mm.ppp** where:

S = slot number of the target parameter

mm = menu number of the target parameter

ppp = parameter number of the target parameter

OUT channel	Mapping parameter	Default value
1	Pr S.03.001	0.06.042
2	Pr S.03.002	0.01.021
3	Pr S.03.003	0.00.000
4	Pr S.03.004	0.00.000
5	Pr S.03.005	0.00.000
6	Pr S.03.006	0.00.000
7	Pr S.03.007	0.00.000
8	Pr S.03.008	0.00.000
9	Pr S.03.009	0.00.000
10	Pr S.03.010	0.00.000
11	Pr S.03.011	0.00.000
12	Pr S.03.012	0.00.000
13	Pr S.03.013	0.00.000
14	Pr S.03.014	0.00.000
15	Pr S.03.015	0.00.000
16	Pr S.03.016	0.00.000
17	Pr S.03.017	0.00.000
18	Pr S.03.018	0.00.000
19	Pr S.03.019	0.00.000
20	Pr S.03.020	0.00.000
21	Pr S.03.021	0.00.000
22	Pr S.03.022	0.00.000
23	Pr S.03.023	0.00.000
24	Pr S.03.024	0.00.000
25	Pr S.03.025	0.00.000
26	Pr S.03.026	0.00.000
27	Pr S.03.027	0.00.000
28	Pr S.03.028	0.00.000
29	Pr S.03.029	0.00.000
30	Pr S.03.030	0.00.000
31	Pr S.03.031	0.00.000
32	Pr S.03.032	0.00.000

6.6 Module menu 4 - Fault values

Menu 4 contains all the fault values that are sent to the mapped output destination parameters when fault values have been configured to be sent using an action parameter.

OUT channel	Parameter
1	Pr S.04.001
2	Pr S.04.002
3	Pr S.04.003
4	Pr S.04.004
5	Pr S.04.005
6	Pr S.04.006
7	Pr S.04.007
8	Pr S.04.008
9	Pr S.04.009
10	Pr S.04.010
11	Pr S.04.011
12	Pr S.04.012
13	Pr S.04.013
14	Pr S.04.014
15	Pr S.04.015
16	Pr S.04.016
17	Pr S.04.017
18	Pr S.04.018
19	Pr S.04.019
20	Pr S.04.020
21	Pr S.04.021
22	Pr S.04.022
23	Pr S.04.023
24	Pr S.04.024
25	Pr S.04.025
26	Pr S.04.026
27	Pr S.04.027
28	Pr S.04.028
29	Pr S.04.029
30	Pr S.04.030
31	Pr S.04.031
32	Pr S.04.032

Safety information
Introduction
Mechanical installation
Electrical installation
Getting started
Parameters
GSD Files
Cyclic data
Non-cyclic data
Control and status words
Diagnostics
PROFIBUS profile (V4)
Advanced features
Legacy features
Glossary of terms

6.7 Module menu 9 - Resources

PCB temperature 1		
S.09.030	Default	N/A
	Range	-128°C to 127°C
	Access	RO

PCB temperature 2		
S.09.031	Default	N/A
	Range	-128°C to 127°C
	Access	RO

Parameters Pr **S.09.030** and Pr **S.09.031** display the current temperature of the 2 internal thermistors within the option module.

7 GSD Files

7.1 What are GSD Files?

GSD files are text files that are used by the PROFIBUS-DP network configuration software tools. They contain information about the device timings, supported features and available data formats for the SI-PROFIBUS device. Drive icon files are also supplied for use with the SI-PROFIBUS configuration software. GSD files are available from your supplier, local Control Techniques Drive Centre or the Control Techniques website (www.controltechniques.com).

7.2 Data consistency

There is a potential problem with data skew when transferring blocks of data to and from a PROFIBUS-DP master controller. Data skew happens when a value is spread across multiple words; when this occurs it is possible that only half of the correct value reaches the destination. Consider the following example:

- The PLC has a value of 0xFFFFFFFF to send to the drive.
- The drive currently has a value of 0x00000000 in a 32-bit parameter.
- The master controller sends the word without consistency.
- The drive receives one 16-bit word and now has the value 0x0000FFFF.
- The drive receives the next 16-bit word and now has the value 0xFFFFFFFF.

To prevent data skew PROFIBUS-DP has a feature known as 'data consistency'. Consistent data defines a block of data words that must ALL be updated before ANY of the new data values are transmitted. Consequently, the message sent over the PROFIBUS-DP network will have a true representation of the required data. Some PLCs have special functions available to transfer blocks of consistent data to a PROFIBUS-DP master controller and guarantee that data skew cannot occur.

7.3 Data configuration

The GSD file describes the modules of input or output words that may be combined to configure the input and output configuration for a specific node. The complete input and output configuration for the node is built by adding the required modules until all of the node's inputs and outputs are defined.

NOTE A module consists of a block of input or output data. Put simply this is a logical collection of data words.

The number of input or output words configured in the drive must match the number of input or output words defined in the master controller; if the master has eight IN and four OUT words the drive must use the same settings to communicate correctly.

The SI-PROFIBUS module uses Pr **S.01.020** and Pr **S.01.021** to independently set the number of input and output words respectively.

NOTE The definition of a data word is 16 bits. By default SI-PROFIBUS casts all data as long words/double words (32 bits), data alignment can be used to reduce this size, see section *S.01.014* on page 36 for more information.

Safety information
Introduction
Mechanical installation
Electrical installation
Getting started
Parameters
GSD Files
Cyclic data
Non-cyclic data
Control and status words
Diagnostics
PROFIdrive profile (V4)
Advanced features
Legacy features
Glossary of terms

7.4 PROFIBUS DP-V1

To use the DP-V1 features in the module, the drive must be configured in the master controller as a 'DPV1' slave.

7.5 GSD compatibility table

Table 7-1 can be used to determine which GSD file should be used.

Table 7-1 Selecting the correct GSD file

Simulated drive	Compatibility mode (Pr S.01.031)	GSD file
Unidrive M700 / M800	Auto detect	UNIM0DB8.GSD
Unidrive M200 / M300 / M400	Auto detect	CTUD0EA5.GSD
Unidrive SP	UniSP	SP__0672.GSD
Unidrive SP with extended diagnostics	UniSP extended	SP__0B4F.GSD
Unidrive Classic	Unidrive Classic	CTU__3345.GSD

NOTE

Unidrive M200/M300/M400 are not supported in version V01.02.00.02 or earlier.

8 Cyclic data

8.1 What is cyclic data?

Cyclic data transfer is a method of transferring data on a regular time period, often known as 'polled data'. High-speed data transfer is achieved by transmitting only data bytes over the PROFIBUS-DP network and using local mapping information within the SI-PROFIBUS and PROFIBUS-DP master controller to ensure that the correct data is sent to the correct locations. The flexibility of the SI-PROFIBUS means that each cyclic data OUT channel can be directed to any read/write drive parameter. Similarly each cyclic data IN channel can use any drive parameter as a source of data.

NOTE

- The term OUT data refers to data that is transmitted out of the master to the slave.
- The term IN data refers to data that is returned from a slave into the master.
- Cyclic data mapping cannot be changed dynamically, as changes to the configuration (mapping parameters, etc.) will only take effect during initialization of the SI-PROFIBUS.
- The maximum number of 16-bit mappings that is possible is 32 with only cyclic data, this requires data alignment to be set to 16.
- The maximum number of 32-bit mappings that is possible is 16 with only cyclic data.

See section 8.7 *Master configuration* on page 52 for more information regarding the use of data alignment with 16-bit parameters.

8.2 Data formats

The SI-PROFIBUS can be configured with up to sixteen 32-bit or thirty-two 16-bit cyclic IN and OUT data words. IN and OUT cyclic data words are mapped using up to 32 mapping (pointer) parameters, one for each mapping.

NOTE

By default all drive parameters are cast as 32-bit (two 16-bit words) therefore thirty-two cyclic words gives sixteen possible drive parameters. Data alignment reduces the number of cyclic words required for drive parameters of 16-bit (or less) to 16 bits thus allowing for thirty-two possible 16-bit parameters. Any 32-bit parameters mapped will still require two 16-bit words even with alignment set to 16.

In addition to cyclic data, non-cyclic data (see section 9 *Non-cyclic data* on page 53) exchange is also possible by the following methods:

- DP-V1 parameter access mode
- Mode 1 - CT Single Word
- Mode 2 - PPO 4 Word

The method used to map cyclic data to and from the PROFIBUS-DP network is similar to the method used in the drive for mapping analog and digital I/O. The reference for the source or target parameter is entered in the mapping parameter in the form **mm.ppp**, where:

mm = menu number of the target/source parameter

ppp = parameter number of the target/source parameter.

Safety information
Introduction
Mechanical installation
Electrical installation
Getting started
Parameters
GSD Files
Cyclic data
Non-cyclic data
Control and status words
Diagnostics
PROFIdrive profile (V4)
Advanced features
Legacy features
Glossary of terms

Table 8-1 SI-PROFIBUS mapping parameters

IN channel	Mapping parameter
1	Pr S.02.001
2	Pr S.02.002
3	Pr S.02.003
4	Pr S.02.004
5	Pr S.02.005
6	Pr S.02.006
7	Pr S.02.007
8	Pr S.02.008
9	Pr S.02.009
10	Pr S.02.010
11	Pr S.02.011
12	Pr S.02.012
13	Pr S.02.013
14	Pr S.02.014
15	Pr S.02.015
16	Pr S.02.016
17	Pr S.02.017
18	Pr S.02.018
19	Pr S.02.019
20	Pr S.02.020
21	Pr S.02.021
22	Pr S.02.022
23	Pr S.02.023
24	Pr S.02.024
25	Pr S.02.025
26	Pr S.02.026
27	Pr S.02.027
28	Pr S.02.028
29	Pr S.02.029
30	Pr S.02.030
31	Pr S.02.031
32	Pr S.02.032

OUT channel	Mapping parameter
1	Pr S.03.001
2	Pr S.03.002
3	Pr S.03.003
4	Pr S.03.004
5	Pr S.03.005
6	Pr S.03.006
7	Pr S.03.007
8	Pr S.03.008
9	Pr S.03.009
10	Pr S.03.010
11	Pr S.03.011
12	Pr S.03.012
13	Pr S.03.013
14	Pr S.03.014
15	Pr S.03.015
16	Pr S.03.016
17	Pr S.03.017
18	Pr S.03.018
19	Pr S.03.019
20	Pr S.03.020
21	Pr S.03.021
22	Pr S.03.022
23	Pr S.03.023
24	Pr S.03.024
25	Pr S.03.025
26	Pr S.03.026
27	Pr S.03.027
28	Pr S.03.028
29	Pr S.03.029
30	Pr S.03.030
31	Pr S.03.031
32	Pr S.03.032

NOTE PROFIBUS does not use decimal points. For example, in Open Loop mode, digital speed reference 1 (Pr **01.021**) has units of Hertz, accurate to 1 decimal place. To write a value of 24.6 Hz to Pr **01.021**, the value must be transmitted as 246.

If a mapping parameter is set to an invalid value (e.g. the destination parameter is read only, or the parameter does not exist), the SI-PROFIBUS will indicate a failure error in the PROFIBUS Network diagnostic parameter (Pr **S.01.006**). The reason for the failure error will be indicated by the mapping status parameter (Pr **S.01.022**) and (**S.01.023**). Refer to page 38 for more details.

8.3 Mapping conflicts

Care must be taken to ensure that there are no clashes between mappings in the SI-PROFIBUS cyclic OUT data and other drive parameters such as:

- Other SI-PROFIBUS cyclic OUT channels
- Mappings from additional option modules if installed
- Analog inputs
- Digital inputs
- Logic outputs
- Motorized pot output
- Comparator outputs
- Variable selected outputs

The SI-PROFIBUS will not indicate if there is a mapping conflict due to any one of the reasons listed. Should a conflict occur and a parameter is written to from two or more different sources, the value of this parameter will depend entirely upon the scan times for the function and the PROFIBUS-DP network. The result would be that a parameter may appear to be steady at a particular value on the drive display, although an occasional glitch in the displayed value may be seen. Internally however, this value may be changing continuously between two values, leading to unusual behavior in the drive.

8.4 Cyclic data mapping errors

The SI-PROFIBUS module will scan and check the PROFIBUS-DP mapping parameter configuration for errors during initialization. If an error is detected, then the SI-PROFIBUS operating status parameter (Pr **S.01.006**) will indicate “Initialized”, and the configuration error detected will be indicated in mapping status parameter, Pr **S.01.022** and **S.01.023**. See page 38 for full details.

8.5 Mapping limitations

When setting mapping values care should be taken not to exceed the data size set in Pr **S.01.020** and Pr **S.01.021**. The data size depends on the size of the mapped parameter and if data alignment is set to 16 or 32 (see Table 8-2).

Table 8-2 Actual data sizes

Parameter size (bits)	Actual data size (bits) alignment=16	Actual data size (bits) alignment=32
1	16	32
8		
16		
32	32	

Consider the following example:

- mapping Pr **S.02.001** to a 32-bit value and **S.02.002** to a 16-bit value
- mapping Pr **S.03.001** to a 32-bit value and **S.03.002** to a 32-bit value
- data alignment set to 16 bits (Pr **S.01.014** set to 16)

would require the following settings to be made:

- Pr **S.01.020** = 3
- Pr **S.01.021** = 4

8.6 Disabling mappings

Any unused mapping parameters (Pr **S.02.001** to Pr **S.02.032** and Pr **S.03.001** to Pr **S.03.032**) should be set to 0.

NOTE

Having unmapped channels between valid mapped channels is not permitted and will result in a configuration error (i.e. Pr **S.01.006** will indicate "First Failure" or "Second Failure").

8.7 Master configuration

The SI-PROFIBUS mapping parameters can be automatically configured by the master controller. If Pr **S.01.008** is set to Auto, then the Input cyclic words (Pr **S.01.020**), Output cyclic words (Pr **S.01.021**), Input source mappings (Pr **S.02.ppp**) and Output destination mappings (Pr **S.03.ppp**) will be set by the master controller using the parameter information specified for the cyclic configuration.

The Data alignment (Pr **S.01.014**) can also be set automatically by the master controller by enabling the BitControl property of the slave device and setting the required alignment value (16BIT or 32BIT) in the network configuration.

If there is no master controller connected to the module, Pr **S.01.006** will indicate "Initialization" (1).

9 Non-cyclic data

9.1 What is non-cyclic data?

Non-cyclic data allows access to any parameter without the need to use cyclic data transfers. This is particularly useful when accessing many different parameters for set-up or archiving of drive settings. The method to use non-cyclic data on the SI-PROFIBUS is by using DP-V1 Parameter Access.

NOTE

Non-cyclic data using the DP-V1 non-cyclic channel must not be confused with the non-cyclic over cyclic method as used with the CT non-cyclic and PPO 4 word modes.

9.1.1 DP-V1 Parameter Access

Non-cyclic data is transmitted after all the cyclic data within the PROFIBUS-DP cycle, depending on the length of the non-cyclic data, this may take several cycles to complete.

9.2 Configuration using non-cyclic data

The SI-PROFIBUS can be configured using the DP-V1 Parameter Access channel non-cyclic data. This is useful when using a master controller to configure the drive; when a drive is initialized only the node address **S.01.004** needs to be set manually. The master can now use the desired mode to set-up the remainder of the parameters.

The configuration parameters for the slot in which the SI-PROFIBUS is located can be accessed in **S.01.ppp** and **MM.ppp**. Any changes made to the configuration parameters will not take effect until the SI-PROFIBUS has been reset. SI-PROFIBUS can be reset by writing a value of 1 to Pr **MM.007**. A brief interruption in PROFIBUS-DP communications may be seen while the reset sequence is in progress.

9.3 SI-PROFIBUS non-cyclic overview

The PROFIBUS specification allows for the standard cyclic process data and the additional acyclic parameter data to be transmitted in the same bus cycle.

The DP-V1 message is contained within the acyclic part of the PROFIBUS-DP cycle and uses the slave node address to access the parameter channel.

For further details of the SI-PROFIBUS functionality refer to the official PROFIBUS website at www.profibus.com

The following services will be supported:

- Class 1 Master Read and Write
- Class 2 Master Read and Write
- Class 2 Master Initiate Connection
- Class 2 Master Abort Connection

A class 1 master must be in data exchange with the slave before it can perform a request via the DP-V1 channel. A class 2 master must initiate the connection with the slave before sending the DP-V1 message, likewise it must then abort the connection when it is no longer required.

NOTE SI-PROFIBUS supports the simultaneous connection to one class 1 master and one class 2 master.

Safety information
Introduction
Mechanical installation
Electrical installation
Getting started
Parameters
GSD Files
Cyclic data
Non-cyclic data
Control and status words
Diagnostics
PROFIdrive profile (V4)
Advanced features
Legacy features
Glossary of terms

SI-PROFIBUS supports the following features:

- DP-V1 Parameter Access
- PROFIdrive PNU Access (see section 12.11 *PROFIdrive PNU access* on page 74)
- Fault Buffer (see section 12.12 *Fault Buffer* on page 75)
- Drive Identification (see section 12.13 *Drive Identification* on page 77)
- Identification and Maintenance Functions (see section 12.14 *Identification and Maintenance Functions* on page 77)

The maximum DP-V1 message length is restricted to 128 bytes including the four bytes of the DP-V1 header and the four bytes of the PROFIdrive request, this leaves a maximum of 120 bytes for the parameter data; the maximum number of parameters that can be read or written in a single message is shown in Table 9-1.

Table 9-1 Single message parameter limitation

Mode	Maximum number of parameters	
	16-bit	32-bit
Read	20	20
Write	12	10

9.3.1 DP-V1 Parameter channel

Drive parameters (and PROFIdrive PNU's) can be accessed using the PROFIdrive Parameter Channel, the global slot number 0 and slot sub-index 47. This is illustrated in Figure 9-1.

NOTE DP-V1 slot numbers 1 and 2 are also allowed when the DP-V1 slot index = 47 (for the I&M function, DP-V1 slot must be zero).

NOTE The PROFIdrive PNU's and I & M functions will be accessible using functions available in the master.

Figure 9-1 DP-V1 Parameter Channel

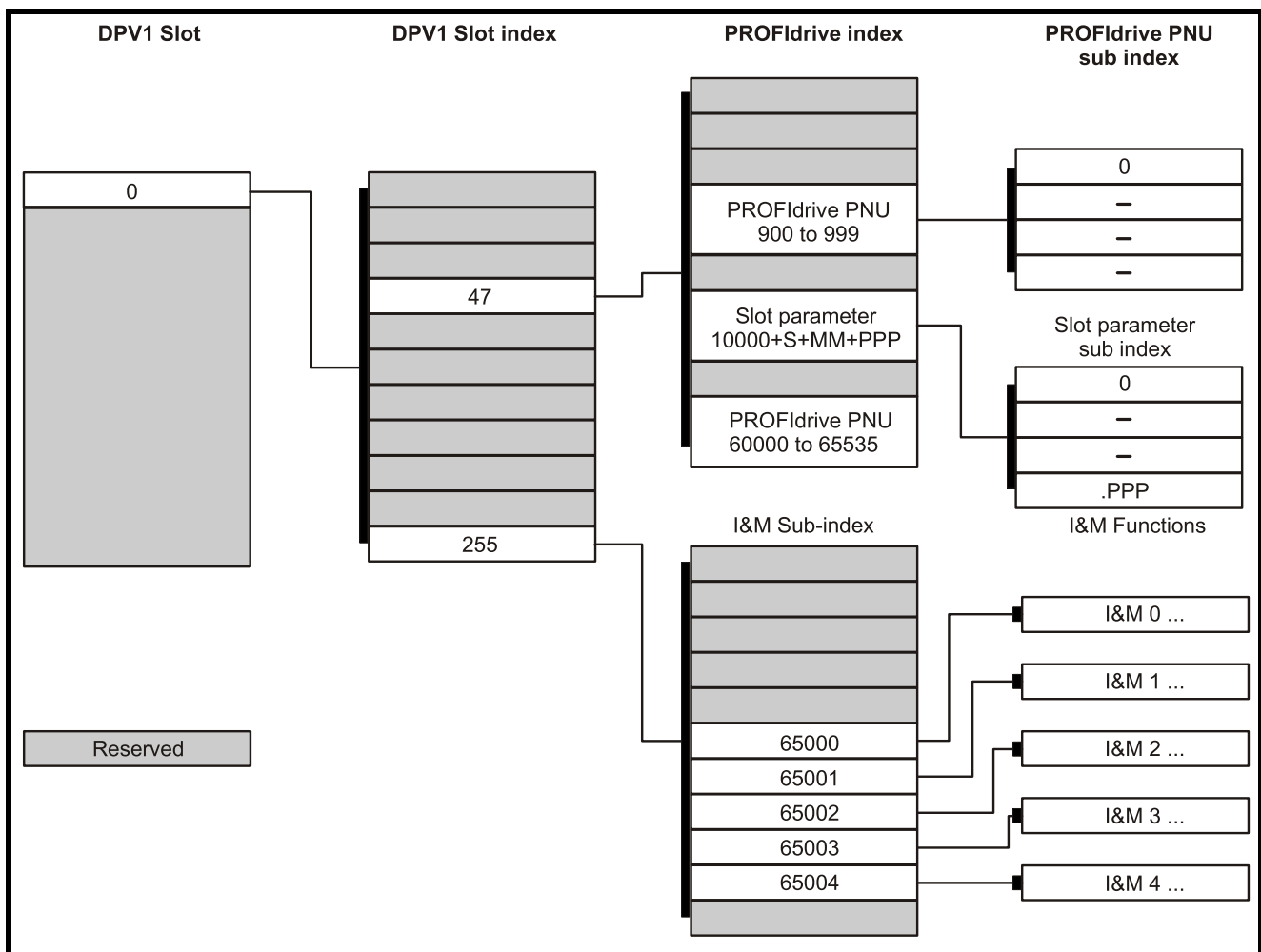

The parameter channel requires a parameter index and subindex to access parameters.

Drive parameters can be accessed by placing the result of the equations:

If the parameter is 99 or less:

$$10000 + (S \times 10000) + (MM \times 100) + ppp$$

in the parameter Index field of the PROFdrive request, the sub-index field is always set to 0.

For example, Pr **01.021** (Preset Reference 1) would be entered as:

$$10000 + (0 \times 10000) + (1 \times 100) + 21 = 10121$$

If the parameter is greater than 99:

$$10000 + (S \times 10000) + (MM \times 100) + 99, \text{ sub-index is set to } (ppp-99).$$

For example, Pr **03.127** (P2 Speed Feedback) would be entered as:

$$10000 + (0 \times 10000) + (3 \times 100) + 99 = 10399 \text{ with a sub-index of } (127-99) = 28$$

PROFdrive Parameters (PNU's) can be accessed by placing the PNU number in the parameter index field and if the PNU data type is an array, then the sub-index field may also be specified.

Safety information
Introduction
Mechanical installation
Electrical installation
Getting started
Parameters
GSD Files
Cyclic data
Non-cyclic data
Control and status words
Diagnostics
PROFdrive profile (V4)
Advanced features
Legacy features
Glossary of terms

10 Control and status words

10.1 What are control and status words?

The control and status words allow the digital control and monitoring of the drive to be implemented using a single data word for each function. Each bit in the control word has a particular function and provides a method of controlling the output functions of the drive, such as run and direction.

Each bit in the status word provides feedback about the drive's state of health and operational condition, such as drive ok, drive at speed, etc.

10.2 Control word

The SI-PROFIBUS control word consists of sixteen control bits some of which are reserved. See Table 10-1 for the individual bit function descriptions.

Table 10-1 Control word bit definitions

b15	b14	b13	b12	b11	b10	b9	b8
	KEYPAD WDOG	RESET	TRIP			JOG REV	REMOTE
b7	b6	b5	b4	b3	b2	b1	b0
AUTO	NOT STOP	RUN	FWD REV	RUN REV	JOG FWD	RUN FWD	ENABLE

To enable fieldbus control, the fieldbus enable signal (Pr **06.043**) and the AUTO bit (b7) must both be set to '1'. When the AUTO bit is reset to 0 the drive will revert to terminal control.

For safety reasons, the external HARDWARE ENABLE signal must be present before the fieldbus control word can be used to start the drive. This terminal is normally controlled by an external "Emergency Stop" circuit to ensure that the drive is disabled in an emergency situation.

The control word REMOTE bit directly controls the drive parameter Pr **01.042**, the function of which is to select the digital speed reference as the source of the drive's speed reference. When the REMOTE bit is reset to 0 the drive will revert to using the external analog speed reference.

The actual digital speed reference selected when REMOTE is set to 1 will be Pr **01.021**, which is also the default mapping for the fieldbus speed reference. However Pr **01.015** can be used to change which of the digital references is selected. For further details on the drive digital speed reference, please refer to the appropriate *Control User Guide*.

Table 10-2 lists in detail the function of each control word bit. For further in-depth details about drive control words and sequencing bits please refer to the appropriate drive documentation.

NOTE When a trip occurs, the drive control word MUST be set to a safe, disabled state. This ensures that the drive does not re-start unexpectedly when it is reset. This can be achieved by continuously monitoring the drive status word, and interlocking it with the control word.

NOTE By default data alignment is set to 32 and therefore the control word will be cast as 32-bit with bits 16 to 31 reserved.

Table 10-2 Control word bit functions

Bit	Function	Description
0	ENABLE	Set to 1 to enable the drive. Resetting to 0 will immediately disable the drive, and the motor will coast to a stop. The external HARDWARE ENABLE signal must also be present before the drive can be enabled.
1	RUN FWD	Set to 1 (with ENABLE set to 1) to run the motor in the forward direction. When reset to 0, the drive will decelerate the motor to a controlled stop.
2	JOG FWD	Set to 1 to jog the motor forward. This signal needs to be used in conjunction with the ENABLE bit. This signal is overridden by a RUN, RUN REV or RUN FWD signal.
3	RUN REV	Set to 1 (with ENABLE set to 1) to run the motor in the reverse direction. When reset to 0, the drive will decelerate the motor to a controlled stop.
4	FWD REV	Set to 1 to select the reverse direction. Set to 0 to run in the forward direction. The RUN signal is used to start and stop the motor.
5	RUN	Set to 1 to run the motor. FWD REV is used to select the direction of motor rotation. When reset to 0, the drive will decelerate the motor to a controlled stop.
6	NOT STOP	Set to 1 to allow the sequencing bit to be latched. If NOT STOP is zero, all latches are cleared and held at 0. Pr 06.004 must be correctly set for this to function.
7	AUTO	Set to 1 to enable fieldbus control of the drive Control Word. The Control Word Enable (Pr 06.043) must also be set to 1. When reset to 0, the drive will operate under terminal control.
8	REMOTE	Set to 1 to select digital speed reference 1 (Pr 01.021), and reset to 0 to select analog reference 1 (Pr 01.036). REMOTE directly controls Pr 01.042 , so reference selector (Pr 01.014) and preset selector (Pr 01.015) must both be set to 0 (default) for the REMOTE bit to work properly.
9	JOG REV	Set to 1 to jog the motor in reverse. This signal needs to be used in conjunction with the ENABLE bit. This signal is overridden by a RUN/RUN REV/RUN FWD command.
10	Reserved	
11	Reserved	
12	TRIP	Set to 1 to trip the drive at any time. The trip display on drive will be CL.bit and the trip code will be 35. AUTO (b7) has no effect on this function. The trip cannot be cleared until TRIP is reset to 0.

Safety information
Introduction
Mechanical installation
Electrical installation
Getting started
Parameters
GSD Files
Cyclic data
Non-cyclic data
Control and status words
Diagnostics
PROFIdrive profile (V4)
Advanced features
Legacy features
Glossary of terms

Bit	Function	Description
13	RESET	A 0-1 transition of the RESET bit will reset the drive from a trip condition. If the reason for the trip is still present, or another fault condition has been detected, the drive will immediately trip again. When resetting the drive, it is recommended to check the status word to ensure that the reset was successful, before attempting to re-start the drive.
14	KEYPAD WDOG	This watchdog is provided for an external keypad or other devices where a break in the communication link must be detected. The watchdog system can be enabled and/or serviced if this bit is changed from zero to one while the control word enabled. Once the watchdog is enabled it must be serviced at least once every second or an SCL trip will occur. The watchdog is disabled when an SLC trip occurs, and so it must be re-enabled when the trip is reset.
15	Reserved	

10.3 Status word

The SI-PROFIBUS status word consists of sixteen control bits some of which are reserved. See Table 10-3 for the individual bit function descriptions.

Table 10-3 Status word bit definitions

b15	b14	b13	b12	b11	b10	b9	b8
(Not used)	Supply loss	Reverse direction running	Reverse direction commanded	Brake resistor alarm	Braking IGBT active	Regenerating	Current limit active
b7	b6	b5	b4	b3	b2	b1	b0
Rated load reached	Above set speed	At set speed	Below set speed	Running at or below minimum speed	Zero speed	Drive active	Drive OK/healthy

The fieldbus status word is mapped directly from the drive status word, Pr **10.040**.

Pr **10.040** is generated by the values of several individual drive status bits; Table 10-4 shows the function indicated by each bit in the status word when set to 1.

Table 10-4 Drive status word bit functions

Bit	Parameter	Description
0	Pr 10.001	bit 0 = 0: Drive not ok (tripped). bit 0 = 1: Drive ok.
1	Pr 10.002	Drive active When bit 1 = 1, the drive is in run mode.
2	Pr 10.003	Zero speed In Open Loop mode, zero speed indicates that the absolute value of the post-ramp speed reference is at or below the zero speed threshold. In RFC-A and RFC-A modes, zero speed indicates that the absolute value of speed feedback is at or below the zero speed threshold.
3	Pr 10.004	Running at or below minimum speed In bipolar mode (Pr 01.010 = 1) Pr 10.004 is the same as zero speed, Pr 10.003. (See above.) In unipolar mode, Pr 10.004 is set if the absolute value of the post-ramp speed reference (Pr 02.001) or speed feedback (Pr 03.002) is at or below minimum speed + 0.5Hz or 5 rpm. (Minimum speed is defined by Pr 01.007.) This parameter is only set if the drive is running.
4	Pr 10.005	Below set speed Only set if the drive is running at below set speed. Refer to Pr 03.006, Pr 03.007 and Pr 03.009 in the drive documentation for more details.
5	Pr 10.006	At speed Only set if the drive is running at set speed. Refer to Pr 03.006, Pr 03.007 and Pr 03.009 in the drive documentation.
6	Pr 10.007	Above set speed Only set if the drive is running at above set speed. Refer to Pr 03.006, Pr 03.007 and Pr 03.009 in the drive documentation for more details.
7	Pr 10.008	Load reached Indicates that the modulus of the active current is greater or equal to the rated active current, as defined in menu 4. Refer to the drive documentation for more details.
8	Pr 10.009	In current limit Indicates that the current limits are active.
9	Pr 10.010	Regenerating Indicates that power is being transferred from the motor to the drive. Regen mode: Indicates that power is being transferred from the drive to the supply.
10	Pr 10.011	Dynamic brake active Indicates that the braking IGBT is active. If the IGBT becomes active, this parameter will remain on for at least one second.

Safety information
Introduction
Mechanical installation
Electrical installation
Getting started
Parameters
GSD Files
Cyclic data
Non-cyclic data
Control and status words
Diagnostics
PROFdrive profile (V4)
Advanced features
Legacy features
Glossary of terms

Bit	Parameter	Description
11	Pr 10.012	Dynamic brake alarm Dynamic brake alarm is set when the braking IGBT is active, and the braking energy accumulator is greater than 75%.
12	Pr 10.013	Reverse direction commanded Direction commanded is set to 1 if the Pre-ramp speed reference (Pr 01.003) is negative and reset to 0 if the Pre-ramp speed reference is zero or positive.
13	Pr 10.014	Reverse direction running A 0 indicates forward direction and a 1 indicates reverse direction. The source of this bit is Pr 02.001 for open loop mode and Pr 03.002 for RFC-A and RFC-S modes.
14	Pr 10.015	Supply loss Supply loss indicates that the drive has detected a supply loss from the level of the DC bus voltage. This parameter can only become active if supply loss ride through or supply loss stop modes are selected. In regen mode, supply loss is the inverse of Pr 03.007.
15	(Not Used)	Reserved

11 Diagnostics

11.1 Overview

This section provides basic diagnostic information intended to resolve the most common problems encountered when setting up an SI-PROFIBUS module on a PROFIBUS-DP network.

A high percentage of problems reported are basic set-up problem that can be avoided by using the information in this chapter. Start by using the Diagnostic flow chart in Figure 11-1 *Diagnostic flow chart* on page 65, to determine the possible cause of a problem. If after following the flow chart you are still experiencing problems, please contact your supplier or local Control Techniques Drive Centre for support.

NOTE

Support is strictly limited to the setting up and networking of the drive.

11.2 Drive trip display codes

If the SI-PROFIBUS module detects an error during operation, it will force a trip on the drive. However, the trip string displayed on the drive will only indicate which slot initiated the trip. The exact reason for the trip will be indicated in the drive trip code parameters (Pr 10.020 and Pr 10.070).

Table 11-1 shows the possible trips that will be displayed on the drive when a problem is detected with the SI-PROFIBUS or when the SI-PROFIBUS initiates a trip.

Table 11-1 Possible drive trip conditions

Trip	Description
SlotX HF	The drive has detected that an option module is present but is unable to communicate with it due to a hardware fault.
SlotX Error	User trip generated by the SI-PROFIBUS.
SlotX Not installed	This trip will occur if a drive slot was previously configured with an option module but on power up, no option module was detected.
SlotX Different	This trip will occur if a drive slot was previously configured with an option module but on power up, a different option module was detected. Replacing a SI-PROFIBUS module with another one will not initiate this trip. The trip will also occur if a SI-PROFIBUS module is installed to a previously unused slot.

11.2.1 Module error codes

If the SI-PROFIBUS detects an error during operation it will force a drive trip. Table 11-2 shows all the possible SI-PROFIBUS error codes.

Table 11-2 SI-PROFIBUS error codes

Value	Text	Description
200	No trip	No trip
201	SW fault	Software fault
202	BG overrun	Background task overrun
203	FW invalid	Invalid firmware
204	Drv unknown	Unknown drive type
205	Drv unsupported	Unsupported drive type
206	Mode unknown	Unknown mode
207	Mode unsupported	Unsupported mode
208	FLASH corrupt	Corrupted NV Flash
209	Dbase init	Database initialization error
210	FS init	File system initialization error
211	Memory alloc	Memory allocation error
212	Filesystem	File system error
213	Save configuration	Error while saving configuration file
214	Load configuration	Error while loading
215	Oht	Overheated configuration file
216	TO drv	Watchdog timeout
217	eCMP	eCMP comms failure
218	TO eCMP slot 1	Slot 1 eCMP timeout
219	TO eCMP slot 2	Slot 2 eCMP timeout
220	TO eCMP slot 3	Slot 3 eCMP timeout
221	TO eCMP slot 4	Slot 4 eCMP timeout

11.2.2 PROFIBUS error code

If the SI-PROFIBUS module detects a PROFIBUS error during operation it will force a drive trip. Table 11-3 shows the possible SI-PROFIBUS error codes.

Table 11-3 SI-PROFIBUS error codes

Value	Text	Description
100	No trip	No trip
101	Link loss	Network link lost
102	Invalid data	Invalid Fieldbus specific data
103	VPC3 stack	VPC3 stack error

11.2.3 SI-PROFIBUS network diagnostic

The operating status of the SI-PROFIBUS module can be viewed in the network diagnostic parameter (Pr **S.01.006**). All possible values of this parameter are described in Table 11-4.

Table 11-4 SI-PROFIBUS operating status

Value	Text	Description
0	Network OK	Network OK/healthy.
1	Intilaization	A part of the SI-PROFIBUS initialization sequence was not successful. If this fault persists after a power-cycle, replace the SI-PROFIBUS. This error may also occur if the PROFIBUS-DP master is not connected.
2	Initialized	The SI-PROFIBUS has initialized correctly and is waiting for the Profibus-DP master to initialise communications. This error may also occur if the PROFIBUS-DP master connection is removed.
3	Network no data	Network OK/healthy but no network cycles per second detected.
4	First Failure	Mapping configuration fail when mappings are set by input mapping menu and output mapping menu (S.01.008 > 0) or ASCII configuration fail when mappings are set by GSD files (S.01.008 = 0).
5	Second Failure	Mapping configuration fail when mappings are set by GSD files (S.01.008 = 0) or ASCII configuration fail when mappings are set by input mapping menu and output mapping menu (S.01.008 > 0).
6	Third Failure	SI-PROFIBUS does not support CTNC or PPO4 (S.01.030 = 1 or 2), and does not support ProfiDrive V2 (S.01.008 > 2).

11.2.4 Mapping status

If the SI-PROFIBUS Network Diagnostic parameter (Pr **S.01.006**) indicates "First Failure" or "Second Failure", a mapping configuration error has been detected. The reason for the error is indicated by the SI-PROFIBUS input mapping status parameter (Pr **S.01.022**) and the SI-PROFIBUS output mapping status parameter (Pr **S.01.023**).

When a mapping error has been corrected, reset the SI-PROFIBUS module by setting **MM.007** to On (1).

The input mapping error codes are described in Table 11-5 on page 64, and the output mapping error codes are described in Table 11-6 on page 64.

Safety information
Introduction
Mechanical installation
Electrical installation
Getting started
Parameters
GSD Files
Cyclic data
Non-cyclic data
Control and status words
Diagnostics
PROFdrive profile (V4)
Advanced features
Legacy features
Glossary of terms

Table 11-5 Input mapping errors

Value	Text	Description
0	No error	No error detected with IN cyclic data mapping configuration.
1	Too many IN objs	Too many IN channels configured
2	No mapping	IN cyclic data length is 0 or there is no IN mapping.
3	Read mismatch	Parameter read error (parameter may not exist)
4	Hole in mappings	IN cyclic data mapping parameters are not contiguous
5	N-C mapping err	A non-cyclic data mode has been mapped more than once in the IN data mapping configuration parameters
6	Duplicate error	Two or more IN cyclic data mapping configuration parameters have been configured with the same destination parameter reference.
7	Length mismatch	Mismatch in data length
8	IN MODE AND PPO	Non-cyclic and PPO STD Tel 1 both exist
9	Data align w PPO	Can't configure PPO when data alignment is set to 32 bits
10	No PPO support	PPO1-PPO5 not supported
11	SP A-D IN map	Input Mapping can't be set by GSD file automatically in SP mode
12	IN AND CTNC PPO4	CTNC and PPO4 not supported

Table 11-6 Output mapping errors

Value	Text	Description
0	No error	No error detected with OUT cyclic data mapping configuration.
1	Mapping exceeded	Too many OUT channels configured
2	No mapping	OUT cyclic data length is 0 or there is no OUT mapping.
3	Write mismatch	Parameter write error (parameter may not exist or might be read-only)
4	Hole in mappings	OUT data mapping parameters are not contiguous
5	N-C mapping err	A non-cyclic data mode has been mapped more than once in the OUT data mapping configuration parameters
6	Duplicate error	Two or more OUT cyclic data mapping configuration parameters have been configured with the same destination parameter reference
7	Length mismatch	Mismatch in data length
8	OUT MODE AND PPO	Non-cyclic and PPO STD Tel 1 both exist
9	Data align w PPO	Can't configure PPO when data alignment is set to 32 bits
10	No PPO support	PPO1-PPO5 not supported
11	SP A-D OUT map	Output Mapping can't be set by GSD file automatically in SP mode
12	OUT AND CTNC PPO4	CTNC and PPO4 not supported

Figure 11-1 Diagnostic flow chart

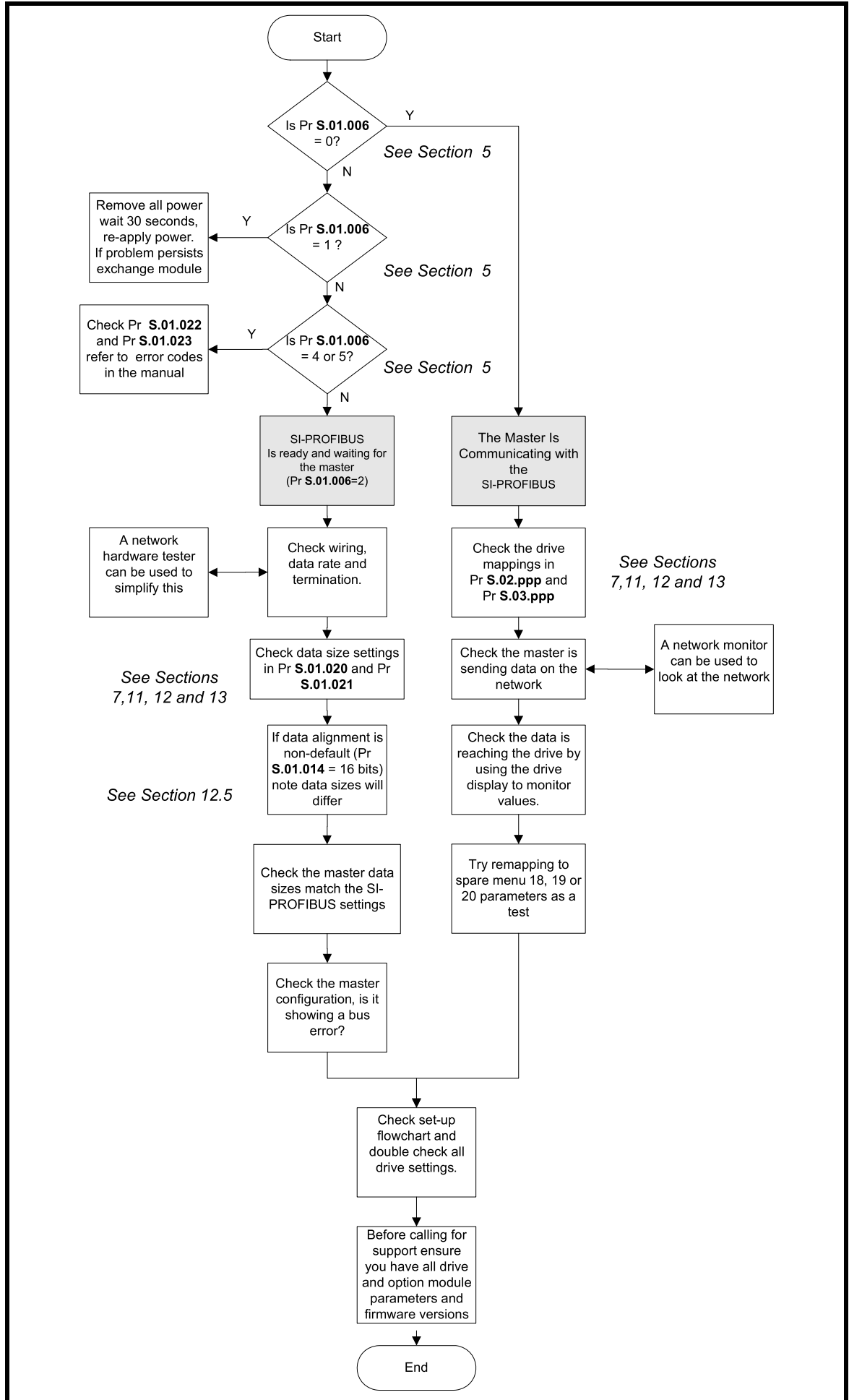

Safety information
Introduction
Mechanical installation
Electrical installation
Getting started
Parameters
GSD Files
Cyclic data
Non-cyclic data
Control and status words
Diagnostics
PROFdrive profile (V4)
Advanced features
Legacy features
Glossary of terms

12 PROFIdrive profile (V4)

12.1 What is PROFIdrive profile?

The PROFIdrive profile is a non-vendor specific standard for controlling drives. PROFIdrive allows compatible drives from different vendors to be controlled and monitored using the same control strategy.

For further details of the PROFIdrive profile refer to the official PROFIBUS web-site at www.profibus.com.

The SI-PROFIBUS module provides support for the “Standard Drive” application class 1 defined in the PROFIdrive V4 specification for speed control mode using Standard Telegram 1.

SI-PROFIBUS supports the following PROFIdrive features:

- Standard Telegram 1
- PROFIdrive PNU Access
- Drive Identification
- Fault Buffer
- Identification and Maintenance Functions

12.2 Standard Telegram 1

To select the Standard Telegrams, the following sequence must be performed:

- Set Pr **S.01.030** to "None" to disable non-cyclic data over the cyclic channel.
- Set Pr **S.01.014** to "16" to set data alignment to 16 bits.
- Set Pr **S.01.008** to "STD Tel 1".
- Pr **S.01.002** or **MM.007** set to “On” to reset the SI-PROFIBUS module.
- Check Pr **S.01.006** does not display any errors (see Table 6-4 on page 33 for further details).
- Save drive parameters (refer to relevant drive documentation for more information).

The Standard Telegram 1 mode may also be configured automatically by the master controller if Pr **S.01.008** is set to Auto.

NOTE Pr **S.01.002** or **MM.007** will automatically revert to ‘Off’ after resetting. Resetting will cause the SI-PROFIBUS to temporary go off-line from the PROFIBUS-DP network.

NOTE After the PROFIdrive profile has been configured and the module reset, if no configuration error is detected then the corresponding mapping parameters will be set automatically by the master controller; i.e. Pr **S.02.001** = 5.00.968; Pr **S.02.002** = 5.01.001; Pr **S.03.001** = 5.00.967 and Pr **S.03.002** = 5.01.003

The Standard Telegram 1 support is a mandatory requirement for Application Class 1 devices, the mapping structure is shown Table 12-1.

Table 12-1 Standard Telegram 1 - mapping structure

IN Data	Function	OUT Data	Function
word 0	PROFIdrive status word	word 0	PROFIdrive control word
word 1	Main Actual Value	word 1	Main Setpoint

12.3 Main Setpoint

Main Setpoint is the speed reference defined in the PROFIdrive profile.

It is scaled such that -32768 to +32767 is -200% to +200% of the maximum speed clamp (Pr **01.006**). The converted value is then written to drive digital speed reference 1 (Pr **01.021**).

The formula used for this conversion is:

$$\text{Pr 01.021} = \frac{\text{Main Setpoint} \times \text{Max Speed Clamp}}{16384}$$

Example 1 - Open loop drive

The drive maximum speed clamp (Pr **1.06**) = 50.0 Hz

The main setpoint value sent from the master to the drive is 13107

Giving:

$$\text{Pr 01.021} = \frac{13107 \times 50.0}{16384} = 40.0\text{Hz}$$

Example 2 - Closed loop / servo drive

The drive maximum speed clamp (Pr **1.06**) = 1500.0 rpm

The main setpoint sent from the master to the drive is 10923

Giving:

$$\text{Pr 01.021} = \frac{10923 \times 1500.0}{16384} = 1000.0\text{rpm}$$

12.4 Main Actual Value

Main Actual Value is the speed feedback reference defined in the PROFIdrive profile.

It is scaled such that -32768 to +32767 is $\pm 200\%$ of the maximum speed clamp (Pr **01.006**). The converted value is derived from:

- Pr **02.001** for open loop drive operation.
- Pr **03.002 RFC-A** or RFC-S drive operating modes.

The formula used for this conversion is:

$$\text{Main Actual Value} = \frac{\text{SF} \times 16384}{\text{Max Speed Clamp}}$$

Where *SF* is the speed feedback parameter, i.e. Pr **02.001** or Pr **03.002** depending upon the drive operating mode.

Example 1 - Open loop drive

The drive maximum speed clamp (Pr **01.006**) = 50.0 Hz

The drive post ramp reference (Pr **02.001**) = 35.0 Hz

Giving:

$$\text{MAV} = \frac{35.0 \times 16384}{50.0} = 11469$$

Example 2 - RFC-A / RFC-S drive

The speed feedback (Pr **03.002**) = 1000.0 rpm

The main actual value can be calculated by:

$$\text{MAV} = 1000.0 \times \frac{16384}{1500.0} = 10923$$

12.5 PROFIdrive (V4) State Machine

The general state machine diagram (V4.0) is shown in Figure 12-1.

The Speed Control state machine is shown in Figure 12-2.

The correct sequence of operation must be used for the state machine otherwise the message will be rejected and the entire sequence must be restarted. The only exception to this rule is when moving from state S2, it is possible to bypass state S3 and jump to state S4 directly.

12.6 Normal Run Sequence

The following sequence can be used to get the motor turning (all bit values refer to the PROFIdrive control word):

- Enable network control (bit 10 = 1, 0x0400)
- Remove all STOP commands (bits 1 & 2 = 1, 0x0406: S1 to S2)
- Set drive to Ready (bit 0 = 1, 0x0407: S2 to S3)
- Enable operation (bit 3 = 1, 0x040F: S3 to S4)
- Enable ramp function generator (bit 4 = 1, 0x041F)
- Unfreeze ramp function generator (bit 5 = 1, 0x043F)
- Enable setpoint value (bit 6 = 1, 0x047F)
- Set the main setpoint value in word 1 (Pr **01.021**)

The motor should now accelerate to the speed set by the main setpoint value.

In order to stop the motor, the following options are available:

- Stop the motor using the drive ramp function: set bit 0 to OFF (0x047E) or
- Stop the motor and coast to zero speed: set bit 1 to OFF (0x047D) or
- Stop the motor using 'Quick stop': set bit 2 to OFF (0x047B)
- Disable drive: set bit 3 to OFF (0x0477)

There is a priority control hierarchy when more than the one stop command is given, these priorities are shown in the general state machine diagram and summarized in the table below.

Table 12-2 Stop command priority

Priority	Control Word Bit	Stop Command
3 (highest)	1	Coast stop
2 (high)	2	Quick stop (Pr 02.022)
1 (low)	0	Ramp stop (Pr 02.021)
0 (lowest)	3	Disable Operation

NOTE

The deceleration rates are set in Pr **02.021** and Pr **02.022** for Ramp Stop and Quick Stop respectively.

Figure 12-1 PROFdrive V4 General State Machine Diagram

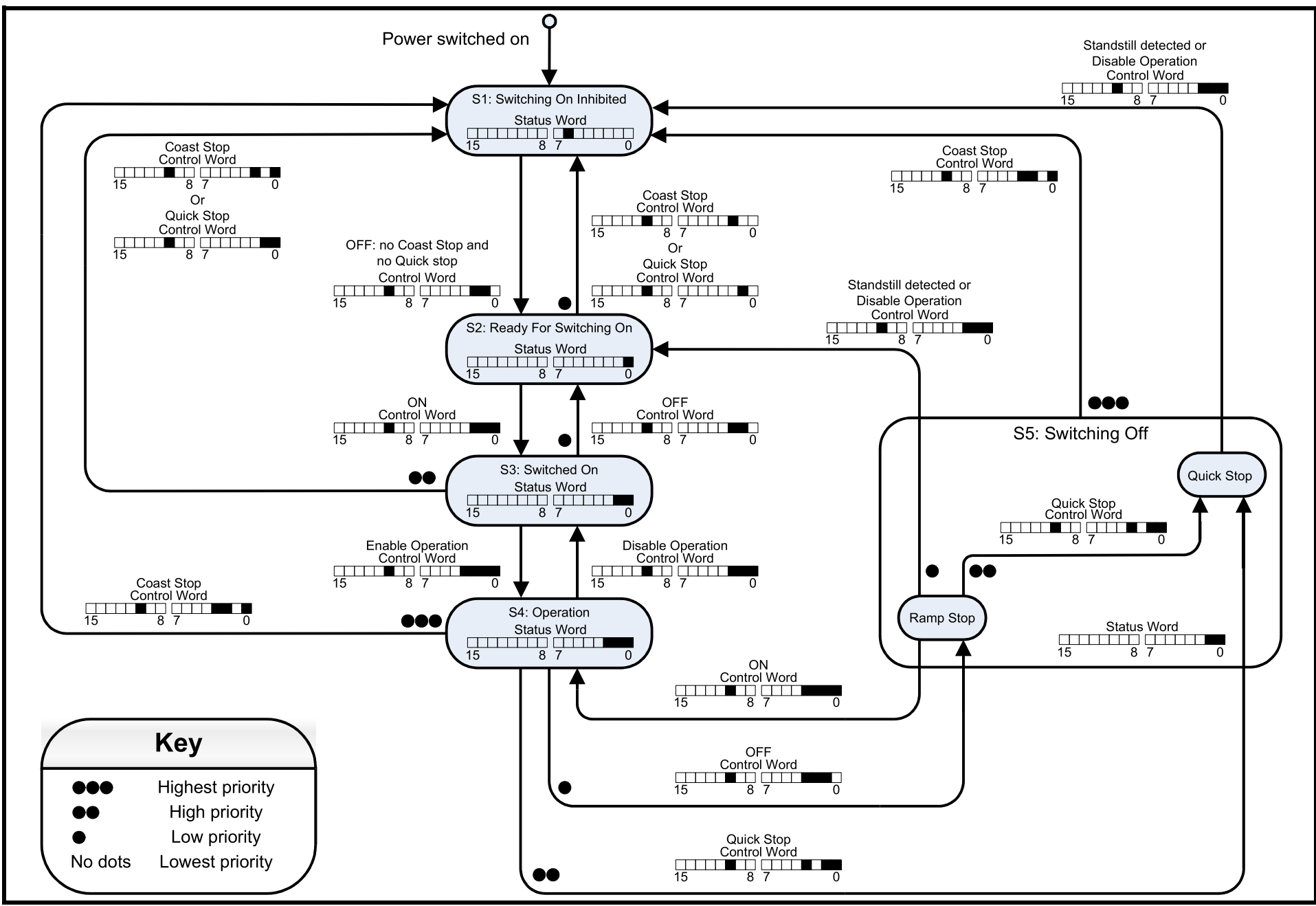

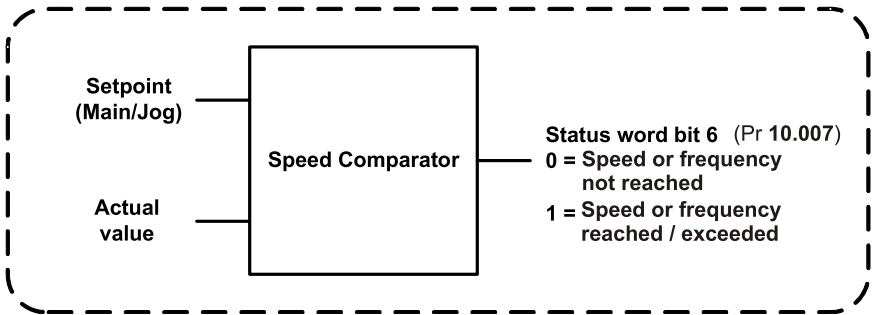
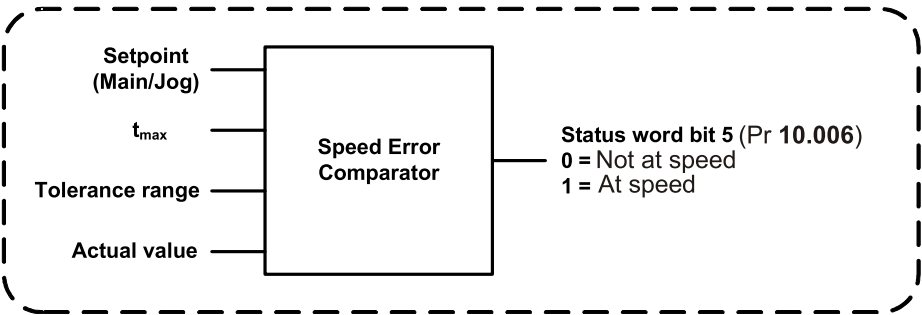
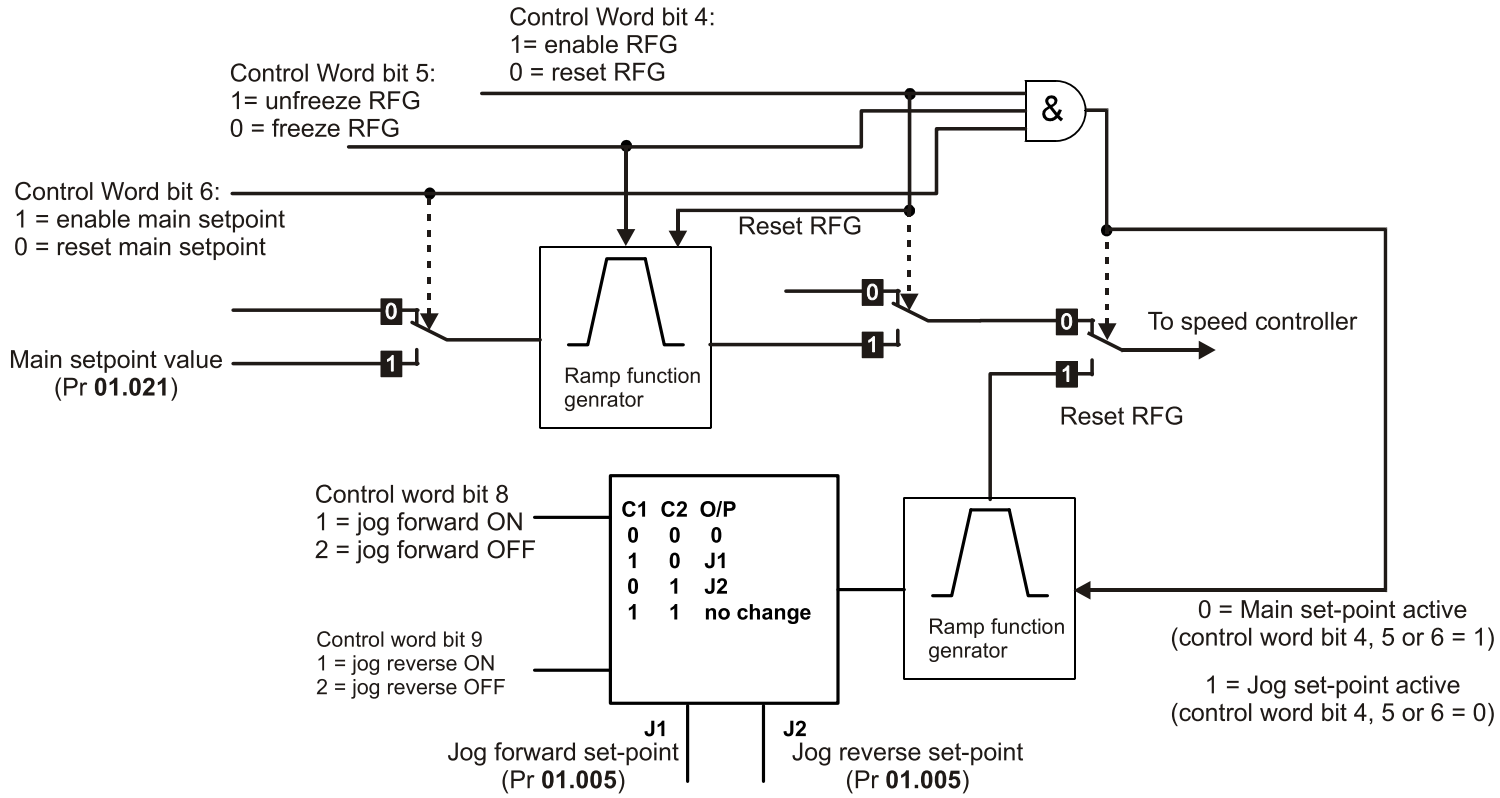

12.7 Stopping the motor using PROFIdrive

There are four methods of stopping the motor, these are:

- Disable Operation (control word bit 3) - Drive is inhibited, motor coasts down to zero speed, status set to 'Switched On'.
- Ramp Stop (control word bit 0) - Motor decelerates under ramp control using deceleration rate1 (Pr **02.021**), drive is inhibited, status set to 'Ready For Switching On'.
- Quick Stop (control word bit 2) - Motor decelerates under ramp control using deceleration rate2 (Pr **02.022**), drive is inhibited, status set to 'Switching On Inhibited'.
- Coast Stop (control word bit 1) - Drive is inhibited, motor coasts down to zero speed, status set to 'Switching On Inhibited'.

12.8 Jogging

In order to use the jogging functions, the drive must be in the operational state (S4) and at standstill and each of the three bits (4, 5 and 6) of the control word must be set to a 0, if any of these three bits are set to a 1 and the drive is at standstill then the jogging functions are disabled and the main setpoint reference is used. The three control bits (4, 5 and 6) have no effect when in jog mode.

To leave jog mode, both jog bits (8 and 9) must not be active and the drive must be at standstill, the normal control bits (4, 5 and 6) will then be active.

The jog direction is controlled by bit 8 (forward) and bit 9 (reverse) of the control word as illustrated in Figure 12-2.

NOTE The jog setpoint is set in Pr **01.005**.

NOTE If both jog forward and jog reverse setpoints are selected at the same time (bits 8 and 9 are both set to a 1) then there will be no change to the jog direction. (i.e. if jog forward was previously selected then the motor will continue to jog forward, and if jog reverse was previously selected then the motor will continue to jog in the reverse direction).

The following sequence can be used to jog the motor in the forward direction:

- Enable network control (bit 10 = 1, 0x0400)
- Remove all STOP commands (bits 1 & 2 = 1, 0x0406: S1 to S2)
- Set drive to Ready (bit 0 = 1, 0x0407: S2 to S3)
- Enable operation (bit 3 = 1, 0x040F: S3 to S4)
- Set jog direction forward (bit 8=1 and bit 9=0, 0x050F) or
- Set jog direction reverse (bit 8=0 and bit 9=1, 0x060F)
- Set jog setpoint value (Pr **01.005**)

The motor should now jog at the speed set by the jog setpoint value.

12.9 PROFIdrive control word

The PROFIdrive control word consists of sixteen control bits some of which are reserved.

Table 12-3 PROFIdrive control word bit functions

Bit	Value	Function	Description
0	1	No Ramp Stop	Ramp Stop command is withdrawn.
	0	Ramp Stop	The motor decelerates under ramp control using deceleration rate1 (Pr 02.021); inhibits the drive and go to 'Ready For Switching On' state.
1	1	No Coast Stop	Coast Stop command is withdrawn.
	0	Coast Stop	Voltage disconnected; inhibit the drive output stage. Main contactor is de-energized (if available), and the drive goes into the 'Switching On Inhibited' status: Motor coasts down
2	1	No Quick Stop	Quick Stop command is withdrawn.
	0	Quick Stop	The motor decelerates under ramp control using deceleration rate2 (Pr 02.022); inhibits the drive and go to 'Switching On Inhibited' state.
3	1	Enable Operation	Enable the drive and accelerate to the specified setpoint.
	0	Disable Operation	Inhibit the drive. Drive coasts down (ramp-function generator to zero or tracking), and into the Switched On' status.
4	1	Enable RFG	Enables the ramp function generator output.
	0	Reset RFG	Ramp function generator output is set to zero. Main contactor remains in, the drive is not isolated from the supply, drive ramps down along the current limit or at the DC bus voltage limit.
5	1	Unfreeze RFG	Unfreezes the ramp function generator output.
	0	Freeze RFG	Freezes the current setpoint from the ramp function generator.
6	1	Enable Setpoint	Selected value at the ramp function generator input is switched in.
	0	Inhibit Setpoint	Selected value at the ramp function generator input is set to 0.
7	1	Fault Acknowledge	Group signal is acknowledged at a positive edge; the drive is in the 'fault' status until the fault has been removed and then goes into 'switch-on inhibit' state.
	0	No meaning	
8	1	JOG1 ON	Prerequisite: Operation is enabled and Main Setpoint=0. The drive accelerates as fast as possible to jogging setpoint (Pr 01.005) in the forward direction.
	0	JOG1 OFF	The drive brakes as fast as possible along the RFG, if 'JOG1' was previously ON, and goes into 'operation enabled' at standstill.
9	1	JOG2 ON	Prerequisite: Operation is enabled and Main Setpoint=0. The drive accelerates as fast as possible to jogging setpoint (Pr 01.005) in the reverse direction.
	0	JOG2 OFF	The drive brakes as fast as possible along the RFG, if 'JOG2' was previously ON, and goes into 'operation enabled' at standstill.
10	1	Network control	Control from the PROFIBUS-DP network, process (cyclic) data is valid.
	0	No control	Process data invalid. Last received valid process data values are retained.
11-15	0	Reserved	

12.10 PROFdrive status word

Table 12-4 gives the description of each bit in the PROFdrive status word.

Table 12-4 PROFdrive status word bit functions

Bit	Value	Function	Comments
0	1	Ready to switch on	Power supply switched on, the drive is inhibited.
	0	Not ready to switch on	Power supply switched off.
1	1	Ready To Operate	Drive is ready to run.
	0	Not Ready To Operate	Drive is not ready to run.
2	1	Operation Enabled	Drive is operational.
	0	Operation Disabled	Drive is not operational.
3	1	Fault Present	Drive faulted, and thus not operational, goes into the switch-on inhibit status after acknowledgment and the fault has been removed. Fault number in the fault parameter.
	0	No Fault Present	Drive ok
4	1	Coast Stop Not Activated	Coast Stop command is not active.
	0	Coast Stop Activated	Coast Stop command is active.
5	1	Quick Stop Not Activated	Quick Stop command is not active.
	0	Quick Stop Activated	Quick Stop command is active.
6	1	Switch-on Inhibited	Power supply switched on, the drive is inhibited.
	0	Switch-on Not Inhibited	Power supply switched on,
7	1	Warning Present	Not Implemented
	0	No Warning Present	Not Implemented
8	1	Speed Error Within Tolerance	'At Speed' (Pr 10.006) = 1
	0	Speed Error Out Of Tolerance	'At Speed' (Pr 10.006) = 0
9	1	Control Requested	The automation system is requested to accept control.
	0	No Control Requested	Control only possible on the device itself.
10	1	Speed Or Frequency Reached/Exceeded	'At Speed' (Pr 10.006) = 1 or 'Above Set Speed' (Pr 10.007) = 1
	0	Speed Or Frequency Not Reached	'At Speed' (Pr 10.006) = 0 and 'Above Set Speed' (Pr 10.007) = 0
11-15	0	Reserved	

Safety information
Introduction
Mechanical installation
Electrical installation
Getting started
Parameters
GSD Files
Cyclic data
Non-cyclic data
Control and status words
Diagnostics
PROFdrive profile (V4)
Advanced features
Legacy features
Glossary of terms

12.11 PROFIdrive PNU access

PROFIdrive parameters (PNUs) may be accessed by placing the PNU number in the Parameter Index field and any sub-index value should be placed in the Sub-index field of the PROFIdrive request.

The full list of supported PROFIdrive PNUs is shown in Table 12-5.

Table 12-5 Supported PROFIdrive PNUs

PNU	Designation	Data type	Access	Explanation
918	PROFIBUS Node ID	Unsigned16	RO	Returns the SI-PROFIBUS network node address.
919	Device system number	Visible string 16	RO	The device system number is a manufacturer specific system ID
922	Telegram selection	Unsigned16	RO	Returns the currently selected telegram
944	Fault message counter	Unsigned16	RO	Incremented by one when the fault buffer changes
947	Fault number	Array(n) Unsigned16	RO	Contains the fault numbers of the recorded faults (see Table 12-6 <i>Fault Buffer Associated PNU's</i> on page 76)
950	Fault buffer scaling	Array(n) Unsigned16	RO	Defines the number of fault situations and the number of faults per situation
963	Actual Baud rate	Unsigned16	RO	Indicates a value corresponding to the actual PROFIBUS network Baud rate detected as defined by the PROFIdrive specification (not the same as Pr S.01.005)
964	Drive Unit ID	Array(n) Unsigned16	RO	Identifies the drive unit
965	Profile ID	Unsigned16	RO	Identifies the PROFIdrive profile version
967	Control Word	Unsigned16	WO	Directly maps to the PROFIdrive control word
968	Status Word	Unsigned16	RO	Directly maps to the PROFIdrive status word
974	Parameter Access Identification	Array(n) Unsigned16	RO	Parameter channel request lengths
975	Drive Object ID	Array(n) Unsigned16	RO	Identifies the drive object
978	List of all DO-IDs	Array(n) Unsigned8	RO	Returns a list of all axis IDs

PNU	Designation	Data type	Access	Explanation
980-989	Defined parameters list	Array(n) Unsigned16	RO	Each PNU in the range contains an array of PNUs and drive parameters available. Only PNU980 is used and contains an array of parameters starting with the PROFIdrive PNUs (excluding PNU980-989) followed by the drive parameters. The array elements are assigned in increasing sequence and consecutively. If an element contains a value of zero then the end of the list has been reached. The array elements are read starting at 0 in increments of 59 elements
1001	Actual value	Unsigned16	RO	Control Techniques specific
1002		Unsigned32	RO	
1003	Setpoint	Unsigned16	WO	
1004		Unsigned32	WO	

NOTE It is beyond the scope of this manual to provide information on the PROFIBUS DP-V1 message frame and PROFIdrive PNUs. For more information please refer to the PROFIBUS web-site www.profibus.com or contact your local Control Techniques Drive Centre.

12.12 Fault Buffer

The fault buffer provides a list of acknowledged and unacknowledged faults, the buffer contains eight elements numbered from 0 to 7, of which the first element (0) contains the active fault (if any). The remaining elements (1 to 7) contain the acknowledged faults in reverse order of occurrence, and therefore element 1 is the most recent acknowledged fault (last fault) and element 7 is the oldest acknowledged fault (first fault).

Acknowledged faults are faults which have been cleared by resetting the drive when a fault is acknowledged; the fault number will be placed in element 1 of the buffer, any existing recorded faults will be moved up (numerically) one element.

If element 7 already contains a fault number then this will be over-written with the value from position 6, the existing fault number is subsequently lost.

Unacknowledged faults are faults which have not been cleared, currently Control Techniques drives only support one fault of this type, the active fault in Pr **10.020**.

The PROFIdrive fault buffer mechanism is shown in Figure 12-3 on page 76.

Figure 12-3 DP-V1 Fault Buffer

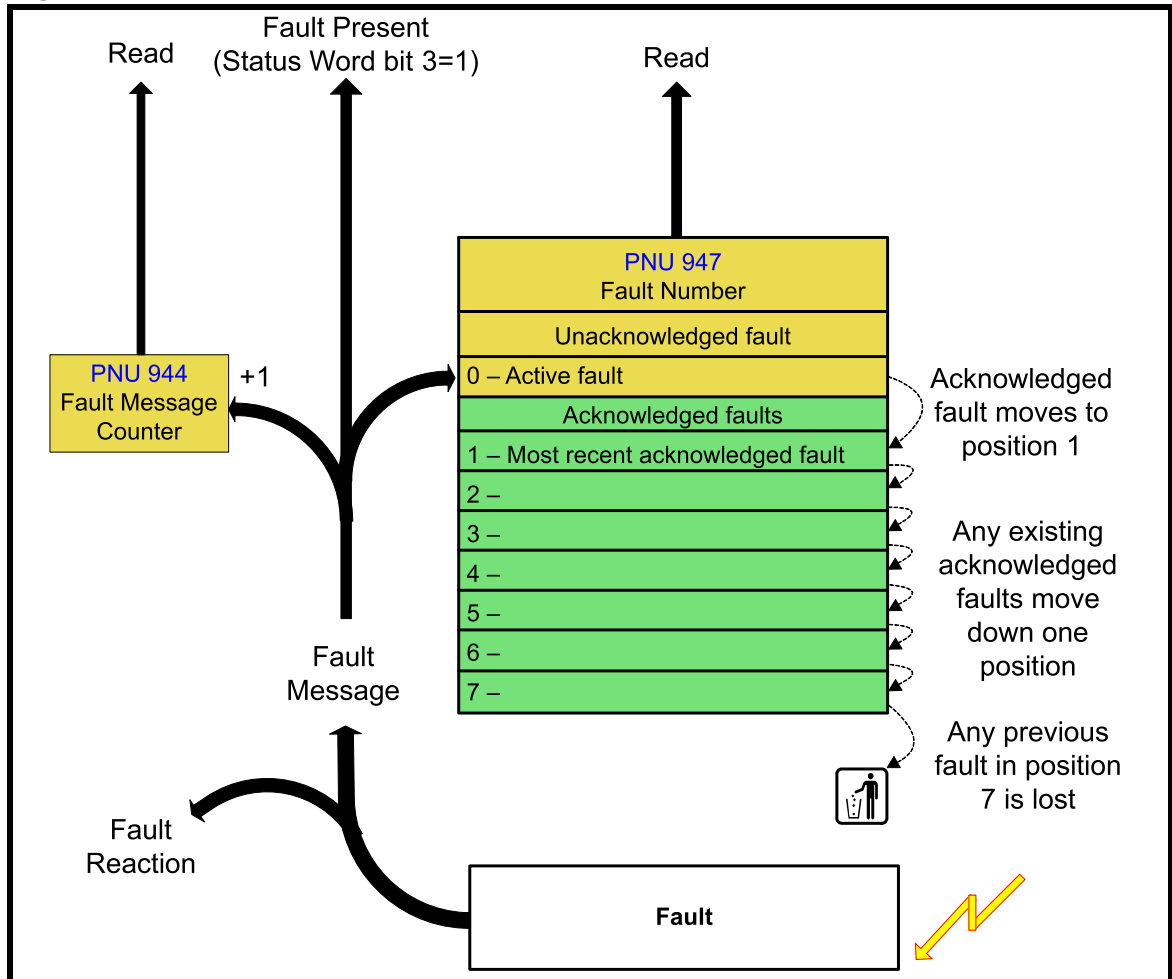

Table 12-6 Fault Buffer Associated PNU's

PNU	Designation	Description	
944	Fault message counter	Incremented by one when the fault buffer changes	
947	Fault number	Contains the fault numbers of the recorded faults	
		Element	Description
		0	Last unacknowledged fault (Pr 10.020)
	1 to 7	Acknowledged faults in reverse order of occurrence	
950	Fault buffer scaling	Defines the number of fault situations and the number of faults per situation. (factory set to 8 and 1 respectively)	

NOTE The fault buffer contents are stored in internal memory and will be cleared on a module reset or power-down.

12.13 Drive Identification

The PROFIdrive specification specifies certain objects that allow network tools to obtain information on the features supported by the slave.

SI-PROFIBUS supports the following PNU's for this purpose.

Table 12-7 Identification PNU's

PNU	Designation	Description
964	Drive Unit Identification	Identifies the drive unit
965	Profile Identification	Identifies the PROFIdrive profile version
974	Parameter Access Identification	Parameter channel request lengths
975	Drive Object Identification	Identifies the drive object
978	List of all DO-IDs	Returns a list of all axis IDs

12.14 Identification and Maintenance Functions

Identification and Maintenance (I&M) functions assist the user in tracking the drive's life cycle through commissioning/start-up, parameterization, diagnosis, repair, etc. SI-PROFIBUS supports the following I&M functions:

- I&M0 (Read Only)
- I&M1 (Read/Write)
- I&M2 (Read/Write)
- I&M3 (Read/Write)
- I&M4 (Read/Write)

All I&M functions are available from masters which support this feature.

13 Advanced features

13.1 SYNC and FREEZE Mode

The SI-PROFIBUS supports the SYNC and FREEZE modes available with most PROFIBUS-DP master controllers.

Cyclic data is put into groups by the PLC allowing multiple cyclic channels to be suspended and updated using the SYNC and FREEZE commands. Data to the drive is controlled by the SYNC command and data from the drive controlled by the FREEZE command. The SYNC command is used in conjunction with the UNSYNC command and the FREEZE command is used in conjunction with the UNFREEZE command.

The SYNC command will cause a single transfer of the previously grouped data and stop any more data from being received by the drive. The SYNC command may be repeated while in this state to allow another single transfer of data to the drive. Issuing an UNSYNC command will revert the drive to continuous cyclic update of the received data.

The FREEZE command will cause a single transfer of the previously grouped data and stop any more data from being transmitted by the drive. The FREEZE command may be repeated while in this state to allow another single transfer of data from the drive. Issuing an UNFREEZE command will revert the drive to continuous cyclic update of the transmitted data.

13.2 Inter-option communication timing

When more than one option module is installed to a drive, communications between modules uses inter-option communications. Inter-option communications is slower than the communications directly to the drive parameters.

Typical access times for direct drive menu access will be in the region of 30 μ s (per parameter), a similar access using inter-option communications will be in the region of 1ms (per parameter).

When using inter-option communications, if parameters are sequential (within the same menu) then up to six parameters may be grouped in to a block, this will take up to 1 ms for this block to be transferred. A total of eight blocks for input and eight blocks for output are available.

13.3 Multi-master operation

The SI-PROFIBUS can be used on PROFIBUS-DP networks containing one or more master controllers. Consult your master controller documentation for information on how to configure a multi-master PROFIBUS-DP network.

NOTE Users must ensure that in networks with multiple master devices that only one master controller is configured to access the SI-PROFIBUS.

NOTE SI-PROFIBUS supports the simultaneous connection of one class 1 master and one class 2 master.

14 Legacy features

14.1 Network compatibility mode

Table 14-1 Network compatibility mode

Pr S.01.031	Default	Auto detect (0)
	Range	Auto detect (0) to Unidrive Classic (4)
	Access	RW

SI-PROFIBUS provides a compatibility mode as standard.

Pr S.01.031 can be used to select which drive the SI-PROFIBUS module is to appear as on the PROFIBUS network, this only applies to the network identification and not the drive functionality.

Table 14-2 Compatibility mode settings

Pr 1.01.031	Text	Description
0	Auto detect	Auto detect
1	Reserved	Reserved
2	Unidrive SP	Unidrive SP mode
3	UniSP extended	Unidrive SP extended diagnostics support
4	Unidrive Classic	Unidrive Classic mode

Using the compatibility mode allows the replacement of drives on a PROFIBUS-DP network, without having to make any changes to the master network configuration, it changes the identity code of the module so that the master controller believes that a similar type drive is present for a particular node.

NOTE When using compatibility mode, ensure that the correct GSD file for the simulated drive is being used and not the actual drive.



This mode only changes the network to emulate the selected drive on the network. Changes to the control method and data size differences must still be considered. This mode does **NOT** allow direct replacement.

When using extended diagnostics (Pr 1.01.031 = 3), the appropriate GSD file using the correct PROFIBUS identification code (0x0B4F) must be used (e.g. 'SP__0B4F.GSD

For GSD file compatibility please refer to Table 7-1 *Selecting the correct GSD file* on page 48.

14.2 PPO Types

SI-PROFIBUS supports all five types of Parameter Process data Object (PPO) defined by the PROFIdrive profile V4. The PROFIdrive profile features four specific functions which the SI-PROFIBUS translates into appropriate drive functions:

- PROFIdrive control word
- Main Setpoint
- PROFIdrive status word
- Main Actual Value

Each PPO mode uses a unique combination of features which are detailed in the following sections.

NOTE Do not confuse PPO 4 mode with Mode 2 - PPO 4 word non-cyclic data, they are not the same.

14.2.1 PPO 1

Table 14-3 PPO 1 mapping structure

IN Data	Function
word 0	Mode 2 non cyclic data (PPO 4-word)
word 1	
word 2	
word 3	
word 4	PROFIdrive status word
word 5	Main Actual Value

OUT Data	Function
word 0	Mode 2 non cyclic data (PPO 4-word)
word 1	
word 2	
word 3	
word 4	PROFIdrive control word
word 5	Main Setpoint

14.2.2 PPO 2

Table 14-4 PPO 2 mapping structure

IN Data	Function
word 0	Mode 2 non cyclic data (PPO 4-word)
word 1	
word 2	
word 3	
word 4	PROFIdrive status word
word 5	Main Actual Value
word 6	User configurable mapping using Pr S.02.004 to Pr S.02.007
word 7	
word 8	
word 9	

OUT Data	Function
word 0	Mode 2 non cyclic data (PPO 4-word)
word 1	
word 2	
word 3	
word 4	PROFIdrive control word
word 5	Main Setpoint
word 6	User configurable mapping using Pr S.03.004 to Pr S.03.007
word 7	
word 8	
word 9	

14.2.3 PPO 3

Table 14-5 PPO 3 mapping structure

IN Data	Function
word 0	PROFIdrive status word
word 1	Main Actual Value

OUT Data	Function
word 0	PROFIdrive control word
word 1	Main Setpoint

14.2.4 PPO 4

Table 14-6 PPO 4 mapping structure

IN Data	Function
word 0	PROFIdrive status word
word 1	Main Actual Value
word 2	User configurable mapping using Pr S.02.003 to Pr S.02.006
word 3	
word 4	
word 5	

OUT Data	Function
word 0	PROFIdrive control word
word 1	Main Setpoint
word 2	User configurable mapping using Pr S.03.003 to Pr S.03.006
word 3	
word 4	
word 5	

14.2.5 PPO 5

Table 14-7 PPO 5 mapping structure

IN Data	Function
word 0	Mode 2 non cyclic data (PPO 4-word)
word 1	
word 2	
word 3	
word 4	PROFIdrive status word
word 5	Main Actual Value
word 6	User configurable mapping using Pr S.02.004 to Pr S.02.020
word 7	
word 8	
word 9	
word 10	
word 11	
word 12	
word 13	

OUT Data	Function
word 0	Mode 2 non cyclic data (PPO 4-word)
word 1	
word 2	
word 3	
word 4	PROFIdrive control word
word 5	Main Setpoint
word 6	User configurable mapping using Pr S.03.004 to Pr S.03.020
word 7	
word 8	
word 9	
word 10	
word 11	
word 12	
word 13	

14.3 Configuring the Profile

To configure the profile to the required PPO mode use the following sequence:

- Set Pr **S.01.014** to 16 to enable data alignment
- Set Pr **S.01.008** to the required PPO profile PP01 to PP05 (5 to 9).
- Configure the mapping parameters as required
- Set **mm.000** to Save parameters or 1000 and press the reset button.
- **S.01.002** or Pr **MM.007** set to On to reset SI-PROFIBUS
- Check Pr **S.01.006** doesn't indicate a fault (see Table 6-4 on page 33 for further details)

Save the drive parameters (refer to the relevant drive documentation for more information).

NOTE Pr **S.01.002** or Pr **MM.007** will automatically reset to Off when the process is complete.

NOTE After the PROFIdrive profile has been configured and the module reset, if no configuration error is detected then the corresponding mapping parameters will be set automatically by the master controller.

If the PROFIdrive profile has been configured after settings have already been made to the cyclic data mapping parameters, the first two or three mapping parameters (depending upon the PPO type chosen) will be over written.

14.4 Setting the non-cyclic mode (non-cyclic over cyclic)

Sending non-cyclic data over the cyclic channel can only be accomplished when the SI-PROFIBUS module is set up for a Unidrive SP in compatibility mode (Pr **S.01.031** = 2 or 3) and the correct GSD file loaded. The correct GSD file for the simulated drive (e.g. SP__0672.GSD)

The term 'non-cyclic over cyclic' is used to refer to non-cyclic data which is transmitted as part of the cyclic data and not using the non-cyclic DP-V1 channel.

Table 14-8 shows how to configure the non-cyclic over cyclic parameter (Pr **S.01.030**) for the required non-cyclic mode.

Table 14-8 Non-cyclic over cyclic data modes

Value	Text	Description
0	None	
1	CTNC	1 Non-cyclic word (CT Single Word mode 1)
2	PPO defined	4 Non-cyclic words (PPO 4 Word mode 2)

14.5 Mode 1 - CT Single Word mode

The CT Single Word (Mode 1) uses one cyclic channel for non-cyclic data. This non-cyclic sub-protocol requires a specific sequence of four or six telegrams to implement the parameter access. Each non-cyclic word or telegram is split into two bytes to implement the sub-protocol. The high byte containing the control codes for each telegram and the low byte containing the data for each telegram.

NOTE By default cyclic data alignment is set to 32 bits, the CT Single Word non-cyclic channel will be 32 bits wide (i.e. uses two words, and data must be transferred on the low word). If cyclic data alignment is set to 16, the CT Single Word non-cyclic channel will revert to 16 bits and only use a single word.

14.5.1 Mapping For CT Single Word non-cyclic data

To configure an SI-PROFIBUS for CT Single Word mode the following steps must be performed:

1. Set Pr **S.01.030** to the required mode.
2. Save the parameters if required.
3. Set **S.01.002** or Pr **MM.007** to ON to reset.

When the SI-PROFIBUS resets, it will map cyclic data IN Word 0 and cyclic data OUT Word 0 to the CT Single Word protocol parameter. All existing mapping parameters will be moved down by one word, (i.e. the previous mappings set in Pr **S.02.001** and Pr **S.03.001** will now appear in Pr **S.02.002** and Pr **S.03.002** etc.). Table 14-9 shows what happens to the mappings when the data format is changed from four cyclic words to four cyclic words with CT Single Word non-cyclic data.

Table 14-9 CT Single Word non-cyclic data mapping

Mapping parameter	Before format change (Pr S.01.030 = 0)		After format change (Pr S.01.030 = 1)	
	Value	Mapping	Value	Mapping
Pr S.02.001	10040	Pr 10.040 , status word		Pr 61.050 , CT Single Word
Pr S.02.002	2001	Pr 02.001 , post ramp speed ref	10040	Pr 10.040 , status word
Pr S.02.003	0	Not mapped	2001	Pr 02.001 , post ramp speed ref
Pr S.02.004 to Pr S.02.032	0	Not mapped	0	Not mapped
Pr S.03.001	6042	Pr 06.042 , control word		Pr 61.050 , CT Single Word
Pr S.03.002	1021	Pr 01.021 , digital speed ref 1	6042	Pr 06.042 , control word
Pr S.03.003	0	Not mapped	1021	Pr 01.021 , digital speed ref 1
Pr S.03.004 to Pr S.03.032	0	Not mapped	0	Not mapped

NOTE If all IN or OUT mapping parameters are being used when the data format change is implemented the last mapping parameter value will be lost.

14.5.2 CT Single Word protocol

All parameter values for the drive must be written as signed 32-bit data values with data alignment set to 32 bits. If data alignment is set to 16, the size of the mapping will depend on the size of the source or destination parameter.

NOTE Decimal point information is inserted automatically when the data value is written to the drive and removed when the data value is read. The number of decimal places of the target parameter must be known. Writing a value of 1234 to a parameter with two decimal places will produce a value of 12.34 in the target parameter. Similarly, reading a value of 12.34 will return a 32-bit integer value of 1234.

Table 14-10 CT Single Word Bit Positions

b15	b14	b13	b12	b11	b10	b9	b8
READ	ERR	Reserved	32-BIT	Stamp Number			
b7	b6	b5	b4	b3	b2	b1	b0
Data Byte							

Table 14-11 CT Single Word Bit Definitions

Bit	Function	Values	Description
0 to 7	Data	0 to 255	Depending on the stamp number of the telegram, this byte contains the menu, parameter or data byte.
8 to 11	Stamp number	0 to 6	Indicates the stamp number of the word. This shows which part of the message is currently in progress. Setting the stamp number to 0 resets the internal non-cyclic state machine.
12	32-BIT	0 = 16-bit data 1 = 32-bit data	Specifies whether a 16-bit or 32-bit data value is to be written to or read from the drive. If 32-BIT is set, telegrams 5 and 6 will be used to transfer the additional data bytes.
13	Reserved	0	Reserved for future use. Always set to 0.
14	ERR	0 = Data OK 1 = Error	Indicates the success or failure of the message. Failure could occur if the parameter does not exist, or is a read-only or write-only parameter. This bit will also be set if the parameter value is out of range in 16-bit mode.
15	READ	0 = Write 1 = Read	Defines whether the data word is part of a READ or WRITE cycle.

NOTE Setting the stamp number to 0 resets the internal non-cyclic state machine. Allowing a new message to be started.

NOTE CT Single Word non-cyclic data uses only one word of data, when using this with data alignment set to 32 requires two 16-bit words. In this mode only the least significant word of the 32-bit word is used.

14.6 Reading parameters using CT Single Word

To read 32-bit parameters using the non-cyclic channel, the following “telegrams” must be transmitted to construct the final message:

- Telegram 1 - define menu number
- Telegram 2 - define parameter number
- Telegram 3 - request high data byte
- Telegram 4 - request mid-high data byte
- Telegram 5 - request mid-low data byte
- Telegram 6 - request low data byte

Table 14-12 CT Single Word Bit Positions

b15	b14	b13	b12	b11	b10	b9	b8
READ	ERR	Reserved	32-BIT	Stamp Number			
b7	b6	b5	b4	b3	b2	b1	b0
Data Byte							

14.6.1 Constructing CT Mode 1 Single Word Read Messages

Figure 14-1 CT Single Word read sequence (Mode 1)

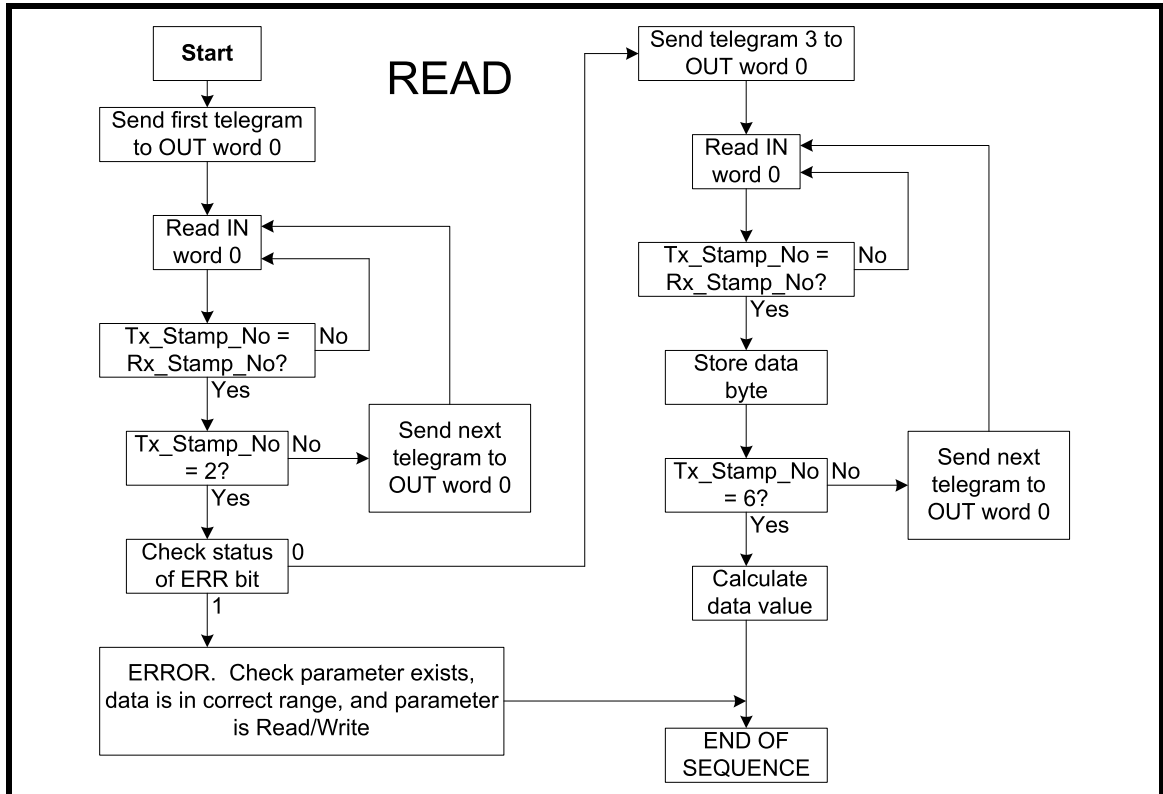

The following example telegrams show how to read the post-ramp speed reference (in rpm with one decimal places) from Pr **02.001** on the drive.

TELEGRAM 1

The first telegram from the PROFIBUS-DP master indicates a READ with stamp number 1. The data byte contains the menu number of the parameter that is to be read.

Example telegram

Bit	b15-b12	b11-b8	b7-b4	b3-b0
Value	1001	0001	0000	0010

Data word = 0x9102

Stamp number = 1

Menu = 2

When the first telegram has been received and processed in the slave node, it is mirrored in the non-cyclic IN word back to the PLC. This is the signal to the master controller program that the first telegram of the message has been received and understood the second telegram can now be transmitted.

Example response

Bit	b15-b12	b11-b8	b7-b4	b3-b0
Value	1001	0001	0000	0010

Data word = 0x9102

Stamp number = 1

NOTE If a telegram produces an error at any point in the sequence the reply to the master will have the error bit ERR set to a 1.

TELEGRAM 2

The second telegram from the PROFIBUS-DP master also indicates a READ cycle, but the stamp number is now 2. The data byte would contain the parameter number for the parameter that is to be read.

Example telegram

Bit	b15-b12	b11-b8	b7-b4	b3-b0
Value	1001	0010	0000	0001

Data word = 0x9201

Stamp number = 2

Parameter = 1

When the second telegram has been received and processed in the slave, it is mirrored in the non-cyclic IN word. This is the signal to the master controller program that the second telegram of the message has been received and the third telegram can now be transmitted.

NOTE

If telegrams 1 and 2 were not received correctly or an invalid parameter was specified, (e.g. parameter is write only, or does not exist), the PROFIBUS-DP interface will set the ERROR bit to 1 (b14 = 1) in the response. The data bits will have no significance. Setting the stamp number to 0 resets the internal non-cyclic state machine.

Example response

Bit	b15-b12	b11-b8	b7-b4	b3-b0
Value	1001	0010	0000	0001

Data word = 0x9201

Stamp number = 2

NOTE

If an error is reported, the non-cyclic data word should be set to 0 to ensure that the non-cyclic state machine is completely reset and ready for the next non-cyclic READ or WRITE sequence.

TELEGRAM 3

The third telegram from the PROFIBUS-DP master acts as the indication to the slave to send the high data byte from the requested parameter. The data byte is not used in this telegram, and should be set to 0.

Example telegram

Bit	b15-b12	b11-b8	b7-b4	b3-b0
Value	1001	0011	0000	0000

Data word = 0x9300

Stamp number = 3

When the third telegram has been received and processed in the slave node, the node will mirror the stamp number in the non-cyclic IN word and load the high byte of the parameter value into the data byte.

Example response

Bit	b15-b12	b11-b8	b7-b4	b3-b0
Value	1001	0011	0000	0000

Data word = 0x9300

Stamp number = 3

Data high byte = 0x00 = 0

TELEGRAM 4

The fourth telegram from the PROFIBUS-DP master acts as the indication to the slave to send the mid-high data byte from the requested parameter. The data byte is not used in this telegram, and should be set to 0.

Example telegram

Bit	b15-b12	b11-b8	b7-b4	b3-b0
Value	1001	0100	0000	0000

Data word = 0x9400

Stamp number = 4

When the fourth telegram has been received and processed in the slave node, the node will mirror the stamp number in the non-cyclic IN word and load the mid-high byte of the parameter value into the data byte.

Example response

Bit	b15-b12	b11-b8	b7-b4	b3-b0
Value	1001	0100	0000	0001

Data word = 0x9401

Stamp number = 4

Data mid-high byte = 0x01 = 1

TELEGRAM 5

The fifth telegram from the PROFIBUS-DP master acts as the indication to the slave to send the mid-low data byte from the requested parameter. The data byte is not used in this telegram and should be set to 0.

Example telegram

Bit	b15-b12	b11-b8	b7-b4	b3-b0
Value	1001	0101	0000	0000

Data word = 0x9500

Stamp number = 5

When the fifth telegram has been received and processed in the slave node, the node will mirror the stamp number in the non-cyclic IN word and load the mid-low byte of the parameter value into the data byte.

Example response

Bit	b15-b12	b11-b8	b7-b4	b3-b0
Value	1001	0101	0010	0101

Data word = 0x9525

Stamp number = 5

Data mid-low byte = 0x25 = 37

TELEGRAM 6

The sixth telegram from the PROFIBUS-DP master acts as the indication to the slave to send the low data byte from the requested parameter. The data byte is not used in this telegram and should be set to 0.

Example telegram

Bit	b15-b12	b11-b8	b7-b4	b3-b0
Value	1001	0110	0000	0000

Data word = 0x9600

Stamp number = 6

When the sixth telegram has been received and processed in the slave node, the node will mirror the stamp number in the non-cyclic IN word and load the low byte of the parameter value into the data byte.

Example response

Bit	b15-b12	b11-b8	b7-b4	b3-b0
Value	1001	0110	1101	1100

Data word = 0x96DC

Stamp number = 6

Data low byte = 0xDC = 220

14.6.2 The parameter re-assembled

The completed value can be assembled as follows to give the complete value as read from the parameter.

$$\begin{aligned} \text{Speed} &= (\text{High byte} * 2^{24}) + (\text{Mid-high byte} * 2^{16}) + \\ &\quad (\text{Mid-low byte} * 2^8) + \text{Low byte} \\ &= (0 * 16777216) + (1 * 65536) + (37 * 256) + 220 \\ &= 75228 \\ &= 7522.8 \text{ rpm} \end{aligned}$$

14.6.3 Writing parameters using CT Single Word

To write to a 32-bit parameter using the non-cyclic channel, the following telegrams must be sent one telegram per network cycle to construct the final message.

- Telegram 1 - define menu number
- Telegram 2 - define parameter number
- Telegram 3 - send high data byte
- Telegram 4 - send mid-high data byte
- Telegram 5 - send mid-low data byte
- Telegram 6 - send low data byte

Figure 14-2 CT Single Word write sequence

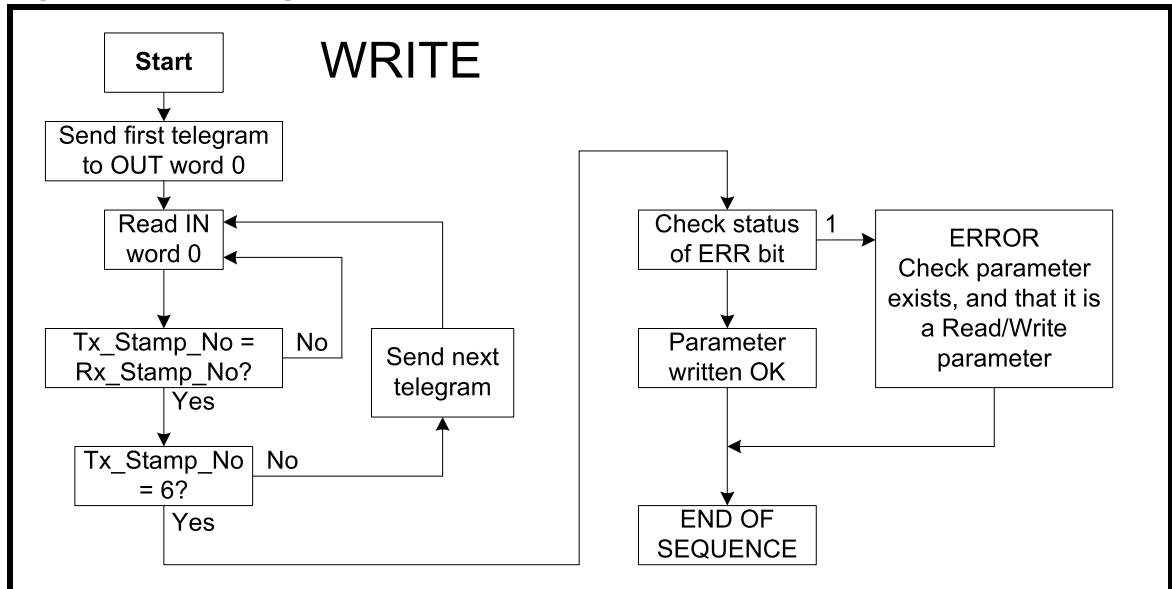

The following telegrams show how to set the digital speed reference 1 (Pr **01.021**) to 12553.9 rpm (32-bit value is 125539) in the drive.

TELEGRAM 1

The first telegram from the PROFIBUS-DP master indicates a WRITE cycle by setting the R/W bit to 0. The stamp number is set to 1. The data byte contains the menu number for the parameter that is to be written to.

Example telegram

Bit	b15-b12	b11-b8	b7-b4	b3-b0
Value	0001	0001	0000	0001

Data word = 0x1101

Stamp number = 1

Menu = 1

When the first telegram has been received and processed in the slave node, it is mirrored in the non-cyclic IN word. This is the signal to the master controller program that the first telegram of the message has been received and understood and the second telegram can be transmitted.

TELEGRAM 2

The second telegram from the PROFIBUS-DP master also indicates a write cycle, but the stamp number is now set to 2. The data byte would contain the parameter number for the parameter that is to be written to

Example telegram

Bit	b15-b12	b11-b8	b7-b4	b3-b0
Value	0001	0010	0001	0101

Data word = 0x1215

Stamp number = 2

Parameter = 21

When the second telegram has been received and processed in the slave node, it is mirrored in the non-cyclic IN word. This is the signal to the master controller program that the second telegram of the message has been received and understood and the third telegram can be transmitted.

TELEGRAM 3

The third telegram from the PROFIBUS-DP master has the stamp number set to 3. The data bits contain the high data byte for the parameter being written to.

Example telegram

Bit	b15-b12	b11-b8	b7-b4	b3-b0
Value	0001	0011	0000	0000

Data word = 0x1300

Stamp number = 3

Data high byte = 0x00

When the third telegram has been received and processed in the slave node, it is mirrored in the non-cyclic IN word. This is the signal to the master controller program that the third telegram of the message has been received and understood and the fourth telegram can be transmitted.

TELEGRAM 4

The fourth telegram from the PROFIBUS-DP master has the stamp number set to 4. The data bits contain the mid-high data byte for the parameter being written to.

Example telegram

Bit	b15-b12	b11-b8	b7-b4	b3-b0
Value	0001	0100	0000	0001

Data word = 0x1401

Stamp number = 4

Data mid-high byte = 0x01 = 1

When the fourth telegram has been received and processed in the slave node, it is mirrored in the non-cyclic IN word. This is the signal to the master controller program that the fourth telegram of the message has been received and understood and the fifth telegram can be transmitted.

TELEGRAM 5

The fifth telegram from the PROFIBUS-DP master has the stamp number set to 5. The data bits contain the mid-low data byte for the parameter being written to.

Example telegram

Bit	b15-b12	b11-b8	b7-b4	b3-b0
Value	0001	0101	1110	1010

Data word = 0x15EA

Stamp number = 5

Data mid-low byte = 0xEA = 234

When the fifth telegram has been received and processed in the slave node, it is mirrored in the non-cyclic IN word. This is the signal to the master controller program that the fifth telegram of the message has been received and understood and the sixth telegram can be transmitted.

TELEGRAM 6

The sixth telegram from the PROFIBUS-DP master has the stamp number set to 6. The data bits contain the low data byte for the parameter that is being written to.

Example telegram

Bit	b15-b12	b11-b8	b7-b4	b3-b0
Value	0001	0110	0110	0011

Data word = 0x1663

Stamp number = 6

Data low byte = 0x63 = 99

When the sixth telegram has been received and processed in the slave node, it will write the data (Pr **01.021** = 12553.9) as transmitted (the decimal point is automatically inserted when the data is transferred to the drive). If the operation is successful, the ERR bit is reset to 0 and the telegram is reflected in the non-cyclic IN word.

Example response - success

Bit	b15-b12	b11-b8	b7-b4	b3-b0
Value	0001	0110	0110	0011

Data word = 0x1663

Stamp number = 6

Data low byte = 0x63 = 99

If there was a problem with writing the data to the defined parameter, e.g. parameter is read only, does not exist, or data is out of range, the ERR bit is set to 1.

Example response - success

Bit	b15-b12	b11-b8	b7-b4	b3-b0
Value	0101	0110	0110	0011

Data word = 0x5663

Stamp number = 6

14.6.4 Abort CT Single Word non-cyclic message

The internal state machine that controls the non-cyclic data transfer will only accept a new telegram if it contains the next expected telegram (i.e. after accepting Telegram 2, the state machine will only respond to Telegram 3. If Telegram 4 is received, it will be ignored).

If an error occurs in the master controller that causes the telegrams to get out of step, the master controller program should time-out, abort the message and reset the non-cyclic state machine.

A Mode 1 non-cyclic message can be abandoned by resetting the state machine. This is done by setting the non-cyclic word to 0.

Example telegram

Bit	b15-b12	b11-b8	b7-b4	b3-b0
Value	0000	0000	0000	0000

Data word = 0x0000

Stamp number = 0

14.6.5 16-bit parameter access

Normally six telegrams would be required to access drive parameters using Mode 1 non-cyclic data. When accessing 16-bit data only four telegrams are required. If an attempt is made to read a 32-bit parameter from the drive the parameter value will be returned, provided that the parameter value does not exceed signed 16-bit limits. If the value is larger than a signed 16-bit value, the ERR bit will be set. When writing data to a 32-bit parameter, the 16-bit data will be treated as a signed 16-bit data value. This limits the range that can be written to a 32-bit parameter.

14.7 Mode 2 - PPO 4 Word mode

PPO 4 word mode of non-cyclic data is a simple method of accessing non-cyclic data without the need for the telegrams required with Mode 1 non-cyclic data and its associated overheads. Mode 2 has the disadvantage of using four words of mappings and reduces the available free mappings accordingly.

14.7.1 Mapping for PPO 4 Word non-cyclic data

To configure an SI-PROFIBUS for PPO 4 word mode non-cyclic data, the following steps must be performed:

1. Set Pr **S.01.030** to the required mode (see section *Non-cyclic over cyclic* on page 41).
2. Set Pr **MM.007** to ON to re-initialize SI-PROFIBUS.
3. Save the parameters if required (see the relevant drive documentation for information on saving drive parameters).

When the SI-PROFIBUS resets, it will map cyclic data IN words 0 to 3 and OUT words 0 to 3 to the PPO 4 Word protocol parameter. All existing mapping parameters will be moved down by one mapping, (i.e. the previous mappings set in Pr **S.02.001** and Pr **S.03.001** will now appear in Pr **S.02.002** and Pr **S.03.002** respectively). Table 14-13 shows what happens to the mapping parameters when the data format is changed from sending no cyclic data over the cyclic channel (Pr **S.01.030**=0) to sending non-cyclic data over the cyclic channel with Mode 2 non-cyclic data. (Pr **S.01.030**=2).

Table 14-13 PPO 4 Word mode data mapping

Mapping parameter	Before format change (Pr S.01.030 = 0)		After format change (Pr S.01.030 = 2)	
	Value	Mapping	Value	Mapping
Pr S.02.001	10040	Pr 10.040 , status word		Pr 61.051 , PPO 4 Word
Pr S.02.002	2001	Pr 02.001 , post ramp speed ref	10040	Pr 10.040 , status word
Pr S.02.003	0	Not mapped	2001	Pr 02.001 , post ramp speed ref
Pr S.02.004 to Pr S.02.032	0	Not mapped	0	Not mapped
Pr S.03.001	6042	Pr 06.042 , control word		Pr 61.051 , PPO 4 Word
Pr S.03.002	1021	Pr 01.021 , digital speed ref 1	6042	Pr 06.042 , control word
Pr S.03.003	0	Not mapped	1021	Pr 01.021 , digital speed ref 1
Pr S.03.004 to Pr S.03.032	0	Not mapped	0	Not mapped

NOTE If all IN or OUT mapping parameters are being used when the data format change is implemented, the last mapping parameter value will be lost.

14.7.2 PPO 4 Word protocol

Table 14-14 shows the data structure required on the OUT data to implement PPO 4 Word request.

NOTE Decimal point information is inserted automatically when the data value is written to the drive and removed when the data value is read. Hence the number of decimal places of the target parameter must be known. Writing a value of 1234 to a parameter with two decimal places will produce a value of 12.34 in the target parameter. Similarly reading a value of 12.34 will return a 32-bit integer value of 1234.

Table 14-14 PPO 4 Word OUT data structure

OUT data word	Function			
	b15-b12	b11	b10-b8	b7-b0
OUT word 0	TASK ID	0	MENU	
OUT word 1	PARAMETER		Reserved	
OUT word 2	DATA HIGH word			
OUT word 3	DATA LOW word			

The PPO 4 Word protocol is controlled by the TASK ID and RESPONSE ID; the TASK ID specifies the transaction required and the remainder of the data words carry the data for the transaction. Table 14-15 lists the possible TASK ID codes.

Table 14-15 TASK ID codes

TASK ID	Function	Description
0	No task	No non-cyclic transaction required
1	Fieldbus specific	
2	Fieldbus specific	
3	Fieldbus specific	
4	Not implemented	Reserved
5	Not implemented	Reserved
6	Request parameter value	Read parameter value from drive. Specify MENU and PARAMETER, set DATA HIGH word and DATA LOW word to 0.

TASK ID	Function	Description
7	Change parameter value (16-bit)	Write 16-bit parameter value to the drive. Specify MENU, PARAMETER and DATA LOW word. (Any value in DATA HIGH word will be discarded.) This function can be used to write to 32-bit drive parameters, but the range of values is limited to 16 bits.
8	Change parameter value (32-bit)	Write 32-bit parameter value to the drive. Specify MENU, PARAMETER, DATA HIGH word and DATA LOW word. This function can also be used to write to 16-bit drive parameters, but if DATA HIGH word is not set to 0, a value over-range error will be reported.
9	Request last parameter reference	Returns the last parameter for the specified menu. Specify MENU. (Values in PARAMETER, DATA HIGH word and DATA LOW word will be discarded.)

Table 14-16 shows the data structure of a PPO 4 Word response which is returned by SI-PROFIBUS.

Table 14-16 PPO 4 Word IN data structure

IN data word	Function			
	b15-b12	b11	b10-b8	b7-b0
IN word 0	RESPONSE ID	0	MENU	
IN word 1	PARAMETER			
IN word 2	DATA HIGH word			
IN word 3	DATA LOW word			

The RESPONSE ID indicates the success or otherwise of the requested transaction. Table 14-17 lists the possible RESPONSE ID codes.

Table 14-17 RESPONSE ID codes

RESPONSE ID	Function	Description
0	No task	No non-cyclic transaction active
1	Fieldbus specific	
2	Fieldbus specific	
3	Not implemented	
4	Transfer parameter value (16-bit)	Returns a 16-bit data value from the request parameter value specified by TASK ID 6, or the successful change parameter value (16-bit) specified by TASK ID 7.
5	Transfer parameter value (32-bit)	Returns a 32-bit data value from the request parameter value specified by TASK ID 6, or the successful change parameter value (32-bit) specified by TASK ID 8.

RESPONSE ID	Function	Description
6	Transfer last parameter reference	Returns the highest parameter for the menu specified by request last parameter reference, TASK ID 9.
7	Error - TASK ID could not be executed	The previously specified TASK ID could not be completed. Word 3 will return an error code to indicate the reason for the TASK ID failure (see table below).
8	Error - read only parameter	Target parameter specified by TASK ID 7 or TASK ID 8 is read only, and cannot be modified.

If RESPONSE ID 7 has been received, the error code can be read from word 3. This will indicate the reason why the TASK ID request failed (see Table 14-18).

Table 14-18 PPO 4 Word error codes

ERROR CODE	Error	Description
0	Invalid menu	The specified menu does not exist.
1	Parameter is read only	The specified parameter is read only, and cannot be written to.
2	Value out of range	The specified data value is out of range for the parameter.
3	Invalid parameter / menu	The specified parameter does not exist.
18	Parameter error	No last parameter information available.

14.7.3 Reading parameters using PPO 4 Word mode

Figure 14-3 shows the sequence of events required to read a drive parameter using the PPO 4 Word non-cyclic channel.

Figure 14-3 PPO 4 Word Read sequence

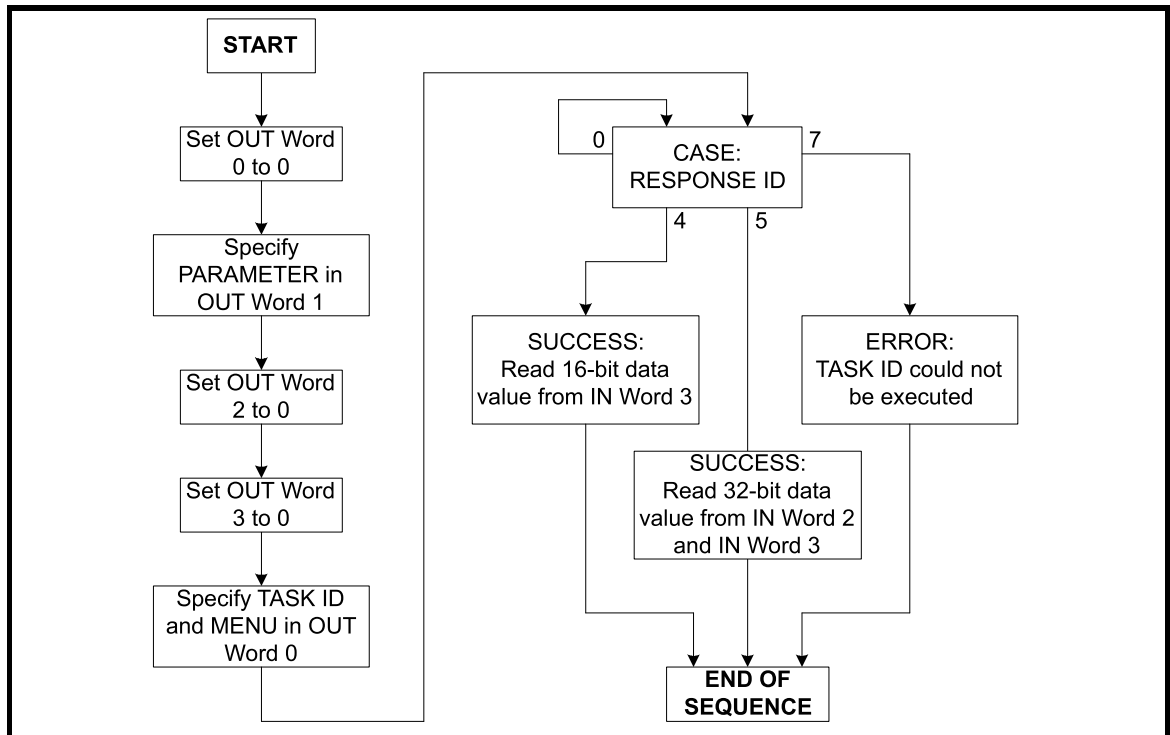

Table 14-19 shows the possible TASK ID and RESPONSE ID combinations that may be seen when attempting to read a parameter value from a drive.

Table 14-19 PPO 4 Word Read TASK ID and RESPONSE ID combinations

Function	TASK ID	RESPONSE ID	Message status
No Task	0	0	No message active.
Request Parameter Value (16-bit)	6	4	Parameter read successfully, 16-bit value returned in word 3.
Request Parameter Value (32-bit)	6	5	Parameter read successfully, 32-bit value returned in words 2 and 3.
Request Parameter Value (16-bit)	6	7	TASK ID 6 could not be executed. Check the error code in IN word 3 for the reason why.
Request Last (Parameter Reference)	9	6	The highest parameter reference in specified menu is available in IN word 3.
Request Last Parameter Reference	9	7	TASK ID 9 could not be executed. Check the error code in IN word 3 for the reason why.

Table 14-20 shows an example set of data words for PPO 4 Word mode. This example will read the value in the post ramp speed reference (Pr **02.001**) in the drive.

Table 14-20 PPO 4 Word read request example

OUT data word	Hex value	Function			
		b15-b12	b11	b10-b8	b7-b0
OUT word 0	0x6002	TASK ID = 6	0	MENU = 2	
OUT word 1	0x0100	PARAMETER = 1		0	
OUT word 2	0x0000	DATA HIGH word = 0			
OUT word 3	0x0000	DATA LOW word = 0			

Table 14-21 shows an example successful read response to the read instruction illustrated above. The value returned is 15284, which equates to 1528.4 rpm.

Table 14-21 PPO 4 Word read response example

IN data word	Hex value	Function			
		b15-b12	b11	b10-b8	b7-b0
IN word 0	0x5002	RESPONSE ID = 5	0	MENU = 2	
IN word 1	0x0100	PARAMETER = 1		0	
IN word 2	0x0000	DATA HIGH word = 0			
IN word 3	0x3BB4	DATA LOW word = 15284			

NOTE

It is important that the correct module is selected from the GSD file to ensure that the PPO 4 word mode block is consistent otherwise data skew may occur. If the OUT data words 0 and 1 are left at the same value, the target parameter will be read or written to (depending on the TASK ID) on every data cycle. If the PPO 4 command is left in the data words, the read will be executed on every poll of the network, effectively providing a continuous read. Care should be taken to ensure the parameters for the read are set-up before the TASK ID is changed from 0 to prevent incorrect data in the returned value.

14.7.4 Writing parameters using PPO 4 Word mode

Figure 14-4 shows the sequence of events required to write to a drive parameter using the PPO 4 Word non-cyclic channel.

Figure 14-4 PPO 4 Word write sequence

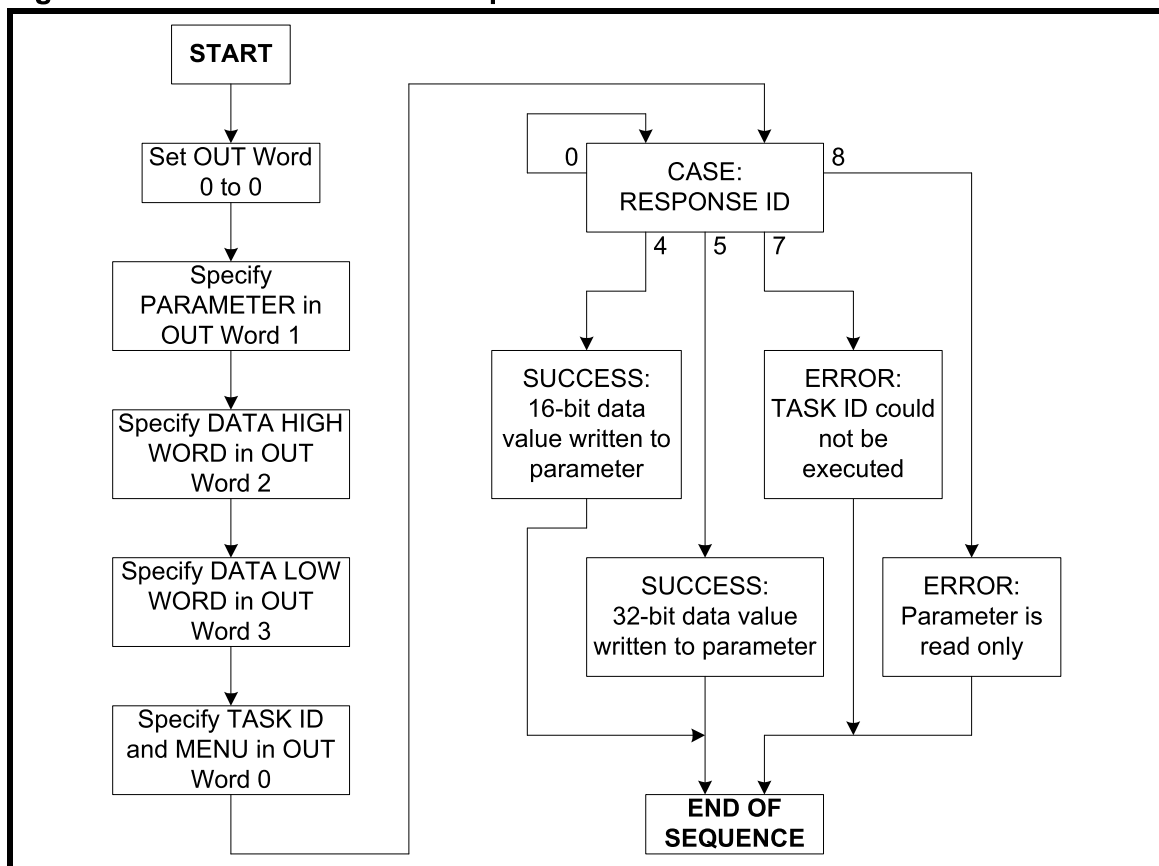

Table 14-22 shows the possible TASK ID and RESPONSE ID combinations that may be seen when attempting to write to the drive.

Safety information
Introduction
Mechanical installation
Electrical installation
Getting started
Parameters
GSD Files
Cyclic data
Non-cyclic data
Control and status words
Diagnostics
PROFIdrive profile (V4)
Advanced features
Legacy features
Glossary of terms

Table 14-22 PPO 4 Word write TASK ID and RESPONSE ID combinations

Function	TASK ID	RESPONSE ID	Message status
No Task	0	0	No message active.
Write Parameter Value (16-bit)	7	4	Parameter (16-bit) written successfully.
Write Parameter Value (32-bit)	8	5	Parameter (32-bit) written successfully.
Write Parameter Value (16-bit)	7	7	TASK ID 7 could not be executed. Check the error code in IN word 3 for the reason why.
Write Parameter Value (32-bit)	8	7	TASK ID 8 could not be executed. Check the error code in IN word 3 for the reason why.
Write Parameter Value (32-bit)	8	8	Parameter is read only, and cannot be written to.

Table 14-23 shows an example set of data words for PPO 4 Word mode. This example will write a value of 1553.9 rpm (32-bit value is 15539) to the digital speed reference 1 (Pr **01.021**) to the drive.

Table 14-23 PPO 4 Word write requests example

OUT data word	Hex value	Function			
		b15-b12	b11	b10-b8	b7-b0
OUT word 0	0x8001	TASK ID = 8	0	MENU = 1	
OUT word 1	0x1500	PARAMETER = 21		0	
OUT word 2	0x0000	DATA HIGH word = 0			
OUT word 3	0x3CB3	DATA LOW word = 15539			

Table 14-24 shows an example successful write response to the write instruction illustrated above in Table 14-23.

Table 14-24 PPO 4 Word write response example

IN data word	Hex value	Function			
		b15-b12	b11	b10-b8	b7-b0
IN word 0	0x5001	RESPONSE ID = 5	0	MENU = 1	
IN word 1	0x1500	PARAMETER = 21		0	
IN word 2	0x0000	DATA HIGH word = 0			
IN word 3	0x3CB3	DATA LOW word = 15539			

NOTE

If the PPO 4 command is left in the data words, the write will be executed on every poll of the network, effectively providing a continuous write. Care should be taken to ensure the parameters for the write are set-up before the TASK ID is changed from 0 to prevent incorrect data being written.

14.7.5 Limitations of non-cyclic data Mode 1 - CT Single Word

CT Single Word non-cyclic data uses only 1 word of data, however when used with data alignment set to 32 (see *Cyclic data alignment* on page 36) this requires two 16-bit words (a single 32-bit word). When used with data alignment set to 32 only the lower 16 bits of the 32-bit word are used.

14.7.6 Using non-cyclic data Mode 2 - PPO 4 Word

Data consistency is important when using PPO4 word (Mode 2) non-cyclic data as each non-cyclic message consists of four words. If there is data skew between any of the non-cyclic words this could result in the wrong data value being written to the wrong parameter.

The GSD file provides the PPO 4 Word which consists of four IN/OUT words with consistency.

If non-cyclic data is required and the DP-V1 non-cyclic channel is not used then the non-cyclic CT Single Word and/or the PPO 4 Word modules must be selected. A total of eight different modules can be selected to configure the input and output configuration of the node.

Safety information
Introduction
Mechanical installation
Electrical installation
Getting started
Parameters
GSD Files
Cyclic data
Non-cyclic data
Control and status words
Diagnostics
PROFIBUS profile (V4)
Advanced features
Legacy features
Glossary of terms

15 Glossary of terms

Address: This is the unique network identification given to a networked device to allow communication on a network. When a device sends or receives data the address is used to determine the source and the destination of the message.

Bit: A binary digit, this may have the value of 1 or 0.

Block mapping: A method of mapping a range of consecutive parameters using only two ascending parameters. This means that by using two mapping parameters up to 32 consecutive mappings may be made.

Byte: A collection of eight binary digits that collectively store a value. This may be signed or unsigned.

Casting: The process of changing between data sizes without changing the value represented, e.g. changing from 16-bit to 32-bit.

Consistency: Describes how data is transmitted between nodes on the network. If data is consistent it is transmitted from node to node as a single entity. Thus preventing data corruption where multiple bytes are transmitted or received individually.

Control word: A collection of binary digits that are used to control the drive. Features typically include directional controls, run controls and other similar functions.

CT Single Word non-cyclic: *see Mode 1 non-cyclic in this section.*

Cyclic channel: An area of the PROFIBUS-DP message frame used for cyclic communication to a single drive parameter.

Cyclic data: This consists of values that are sent at regular or cyclic intervals across the network. A typical use of cyclic data would be the transmission of a speed reference or a control word.

Data alignment: By default SI-PROFIBUS transmits values as 32 bits on the network. It is possible by using data alignment to reduce the number of bits transmitted when sending 16-bit (or smaller) values on the network to 16-bit (32-bit values will still be transmitted as 32 bit values). This has the advantage of reducing the volume of traffic on the network and allowing more parameters to be mapped within the SI-PROFIBUS.

Data format: Determines the quantity and function of the network data.

Data rate: Determines the communication speed of the network, the higher the value the more data can be sent across the network in the same time period.

Device: A piece of equipment connected to a network, this may be any type of equipment including repeaters, hubs, masters or slaves.

Direct data mapping: Data is sent directly to the mapping parameters in the drive rather than the parameters redirecting the data to another parameter.

Double word: A 32-bit word, this may be signed or unsigned.

DPV 0,1,2: This describes the specification version of SI-PROFIBUS used.

Grounding/Earthing: Describes the electrical safety or shielding connections for the module.

Endian format: When a value uses more than eight bits to represent its value it needs to be sent in sets of eight bits (bytes) across the network, the endian format determines the order the bytes that constitute the whole value are transmitted.

Event task: A way to use a message or change of state to trigger a software routine.

FREEZE: A method of preventing input state changes from being sent to the master, until a FREEZE signal is sent, this is used in conjunction with UNFREEZE.

Grounding: See Earthing

Groups: Groups are used with the SYNC and FREEZE commands. A group defines which nodes respond to a specific SYNC or FREEZE command.

GSD file: A file that defines the properties of a node. The file contains information describing the features available on the device.

IN data: Data that is returned from a slave device to the PROFIBUS master.

Long word: A 32-bit data word that may be signed or unsigned.

Network Loss Trip: A way to determine when a node has lost contact with the master.

Node: A device on the network. This may be either a device such as a drive or part of the network such as a repeater.

Non-Cyclic Data: Data that is requested or sent by the master as required. This is not sent on a regular basis and generally allows access to any parameter. This is useful for occasional changes or configuration purposes.

Main actual value: This gives feedback on the running speed of the drive when using the PROFdrive profile.

Main Setpoint: The value used to determine the speed of the drive when using the PROFdrive profile.

Mapping: The process of linking PROFIBUS values to parameters within the drive.

Master: The controlling device on the network, generally this will include programming features.

Mode 1 non-cyclic: A method of sending non-cyclic data using a single word.

Mode 2 non-cyclic: A method of sending non-cyclic data using four words.

Safety information
Introduction
Mechanical installation
Electrical installation
Getting started
Parameters
GSD Files
Cyclic data
Non-cyclic data
Control and status words
Diagnostics
PROFdrive profile (V4)
Advanced features
Legacy features
Glossary of terms

PROFIdrive profile: A standardized method of controlling drives that is independent of the manufacturer.

Poll rate: The rate at which cyclic data is sent and received on the network.

PPO Modes: Different operational modes within the PROFIdrive profile. PPO 4 mode is not the same as Mode 2 - PPO 4 Word mode non-cyclic data.

PPO 4 Word non-cyclic mode: see Mode 2 non-cyclic in this section. This is not the same as PPO4 mode.

Response ID: The response code of the message received when using PPO4 word non-cyclic communication.

Scan rate: See Poll rate in this section.

Segment: An electrically separate part of the network. Each segment requires correct termination to ensure reliable operation. Due to electrical limitations the maximum number of devices on a segment is limited to 32.

Shielding: A connection to provide additional noise immunity on a network cable.

Slave: A device on the PROFIBUS network such as a drive or sensor. A slave device will only respond to messages from a master.

Status word: A value that denotes the status of the drive. Each bit within the word will have a specific meaning.

SYNC: A method of preventing output state changes from being actioned by the slave, until a SYNC signal is sent, this is used in conjunction with UNSYNC.

Task ID: The code used to describe the purpose of a message using PPO 4 word non-cyclic communication.

Telegram: A message used within Mode 1 non-cyclic data communication. This term is sometimes used to represent a generic message on the network.

Termination: This is used at both ends of a network segment to prevent reflections and reduce noise. On PROFIBUS, termination is provided by a powered network of resistors.

UNSYNC: Used to restore outputs in a slave to normal operation following a SYNC command.

UNFREEZE: Used to restore inputs in a slave to normal operation following a FREEZE command.

Watchdog: A method used to determine if a communication system is ok. A typical watchdog scheme uses a handshaking system to check both the master and slave are participating in communications.

Word: A collection of 16 binary digits.

Index

Numerics

16-bit parameter access	92
2 cyclic channels only	50

A

Abort CT single word	91
Above set speed	59
At speed	59

B

Below set speed	59
-----------------------	----

C

Cable	18
Cable shield connections	18
Cautions	6
Configuring the profile	80
Connectors	18
Consistency	47
Control word	56
CT single word protocol	83
Current limit	59
Cyclic data	49, 78

D

Data alignment	49, 78
Data configuration	47
Data formats	49
Data mapping errors	51
Device loading	19
Diagnostics	61
Disabling cyclic data channels	52
Disabling mappings	52
DP-V1 Drive Identification	77
DP-V1 Fault Buffer	75, 76
DP-V1 Identification and Maintenance Functions	77
DP-V1 Parameter Access	54
DP-V1 PROFIdrive PNU access	74
DP-V1 Standard Telegram 1	66
DP-V1 State Machine	68
Drive active	59
Drive Identification	77
D-Type pin out	17
Dynamic brake active	59

E

Electrical installation	17
Electrical safety	6

F	
Fault Buffer	75
Formats	49
FREEZE	78
G	
Getting started	20
Glossary of terms	100
GSD	47
GSD compatibility	48
H	
Hardware enable	56
I	
Inter-option communication timing	78
J	
Jogging	71
M	
Mapping errors	51
Mapping parameters	50
Mode 1	82, 98
Mode 2	92, 99
N	
Network compatibility mode	79
Network length	19
Network loss timeout error	78
Network termination	18
Node address	22
Non-cyclic data	53
Non-cyclic mode	82
Normal Run Sequence	68
O	
Option module identification	12
Overview	12
P	
PPO 1	80
PPO 2	80
PPO 3	66, 81
PPO 4	81
PPO 4 word	99
PPO 4 word mode	92
PPO 4 word read	95
PPO 4 word write	97
PPO 5	81
PPO types	66
PROFIBUS DP-V1 Overview	53
PROFIdrive (V4) State Machine	68
PROFIdrive control word	72
PROFIdrive PNU access	74

PROFIdrive profile	66
PROFIdrive status word	73
PROFIdrive V4 General State Machine Diagram	69
PROFIdrive V4 Speed Control State Machine Diagram	70
R	
Reading parameters using CT Single Word	84
Regenerating	59
Running at or below minimum speed	59
S	
Set-up flow chart	21
Single word	98
Single word mode	82
Single word non-cyclic data	83
Specification	12
Speed Control State Machine	70
Spurs	19
Standard Telegram 1	66
Status word	58
Status word bit functions	59
Stopping the motor using PROFIdrive	71
SYNC	78
SYNC and FREEZE Mode	78
T	
Telegrams	85
Terminal descriptions	17
Termination	18
U	
UNFREEZE	78
UNSYNC	78
V	
V4.0 General State Machine Diagram	69
W	
Warnings	6
Watchdog	102
Writing parameters using CT Single Word	88
Writing parameters using PPO 4 Word mode	97
Z	
Zero speed	59

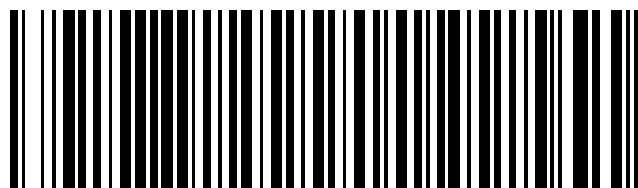

0478-0011-04